

ELEKTRIKOMPONENDID JUHTIMISKESKUSTELE

Tootekataloog 2020/2021



Mitmesugused rahvusvahelised sertifikaadid:



CHINT

KLINKMANN

www.klinkmann.ee

SISUKORD

Kaitselülitid.....	3
Rikkevoolulülitid	5
NL210 ülevoolukaitseta jääkvoolulüliti.....	6
Rikkevoolulülitid ülevoolukaitsega.....	7
Kompaktülitid	9
Õhklülitid.....	13
Kontaktorid	16
Käivitid	23
Kontaktorid,termoreleed ja käivitid	27
Juhtnupud ja märgulambid	28
Moodularvestusega märgulambid, juhtlülitid, koormuslülitid ja ajareleed	30
Nupud ja märgulambid	31
Moodularvestusega koormuslahklülitid	32
Pealülitid	33
Voolutrafod	34
Terasest DIN paigaldussiinid.....	35
Kaablirennid.....	36





Kaitselülitid NB1

1. Üldist



NB1

- 1.1 Lühisekaitse
- 1.2 Ülekoormuskaitse
- 1.3 Lülitusfunktsioon
- 1.4 Isoleeritud
- 1.5 Lülite asendi indikaator
- 1.6 Edasiarendatud voolupiiramistehnoloogia
- 1.7 Õhuvähe parandab jahutust
- 1.8 Väljatõmmatav DIN-siini hoidik lihtsaks kinnitamiseks

2. Tehnilised andmed

Standard		IEC/EN 60898-1	IEC/EN 60947-2	UL1077	UL1077
Nimivool, In	A	1, 2, 3, 4, 6, 10, 13, 16	20, 25, 32, 40, 50, 63		
Klemmid		1P, 2P, 3P, 4P	1P, 2P, 3P, 4P	1P, 2P, 3P, 4P	1P, 2P
Nimipinge, Ue	V	240/400	240/415	277/480	110/125
Nimisagedus			50/60Hz		DC
Nimilohutusvõime	A	6000/10000	6k	5k	10k
Energiapiiramisklass		3			
Pingeimpulsi taluvus (1,2/50) Uimp	V		6000		
Termolüliti karakteristikud		B, C, D	8-12In	B, C, D	4-7In, 7-14In
Elektriline kasutusiga			8, 000		
Mehaaniline kasutusiga			20, 000		
Kinnitus		DIN-siinile EN 60715 (35 mm) kiirkinnitusega			
Ühendus		ülevalt ja alt			
Abilüliti		Jah			
Töövoolulüliti		Jah			
Alapingelüliti		Jah			
Häirenupp		Jah			

3. Karakteristikud

IEC/EN 60898-1

karakteristikud B, C ja D

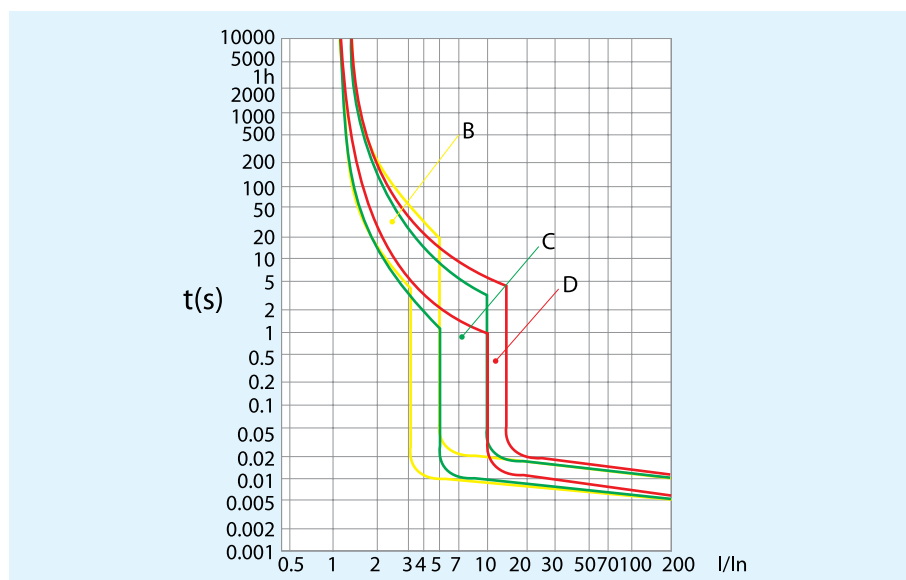

Elektrilevi heakskiit toodetel 1 – 125 A

NB1

Kirjeldus	Pakend	Tootekood 6kA series
NB1 6kA 1P B1	12	NB1631NB1A
NB1 6kA 1P B2	12	NB1631NB2A
NB1 6kA 1P B3	12	NB1631NB3A
NB1 6kA 1P B4	12	NB1631NB4A
NB1 6kA 1P B6	12	NB1631NB6A
NB1 6kA 1P B10	12	NB1631NB10A
NB1 6kA 1P B13	12	NB1631NB13A
NB1 6kA 1P B16	12	NB1631NB16A
NB1 6kA 1P B20	12	NB1631NB20A
NB1 6kA 1P B25	12	NB1631NB25A
NB1 6kA 1P B32	12	NB1631NB32A
NB1 6kA 1P B40	12	NB1631NB40A
NB1 6kA 1P B50	12	NB1631NB50A
NB1 6kA 1P B63	12	NB1631NB63A
NB1 6kA 1P C1	12	NB1631NC1A
NB1 6kA 1P C2	12	NB1631NC2A
NB1 6kA 1P C3	12	NB1631NC3A
NB1 6kA 1P C4	12	NB1631NC4A
NB1 6kA 1P C6	12	NB1631NC6A
NB1 6kA 1P C10	12	NB1631N10A
NB1 6kA 1P C13	12	NB1631NC13A
NB1 6kA 1P C16	12	NB1631NC16A
NB1 6kA 1P C20	12	NB1631NC20A
NB1 6kA 1P C25	12	NB1631NC25A
NB1 6kA 1P C32	12	NB1631NC32A
NB1 6kA 1P C40	12	NB1631NC40A
NB1 6kA 1P C50	12	NB1631NC50A
NB1 6kA 1P C63	12	NB1631NC63A
NB1 6kA 1P D1	12	NB1631ND1A
NB1 6kA 1P D2	12	NB1631ND2A
NB1 6kA 1P D3	12	NB1631ND3A
NB1 6kA 1P D4	12	NB1631ND4A
NB1 6kA 1P D6	12	NB1631ND6A
NB1 6kA 1P D10	12	NB1631ND10A
NB1 6kA 1P D13	12	NB1631ND13A
NB1 6kA 1P D16	12	NB1631ND16A
NB1 6kA 1P D20	12	NB1631ND20A
NB1 6kA 1P D25	12	NB1631ND25A
NB1 6kA 1P D32	12	NB1631ND32A
NB1 6kA 1P D40	12	NB1631ND40A
NB1 6kA 1P D50	12	NB1631ND50A
NB1 6kA 1P D63	12	NB1631ND63A
NB1 6kA 2P C6	6	NB1632NC6A
NB1 6kA 2P C10	6	NB1632NC10A
NB1 6kA 2P C13	6	NB1632NC13A
NB1 6kA 2P C16	6	NB1632NC16A
NB1 6kA 2P C20	6	NB1632NC20A
NB1 6kA 2P C25	6	NB1632NC25A
NB1 6kA 2P C32	6	NB1632NC32A
NB1 6kA 2P C40	6	NB1632NC40A
NB1 6kA 2P C50	6	NB1632NC50A
NB1 6kA 2P C63	6	NB1632NC63A
NB1 6kA 2P D4	6	NB1632ND4A
NB1 6kA 2P D6	6	NB1632ND6A
NB1 6kA 2P D10	6	NB1632ND10A
NB1 6kA 2P D13	6	NB1632ND13A
NB1 6kA 2P D16	6	NB1632ND16A
NB1 6kA 2P D20	6	NB1632ND20A
NB1 6kA 2P D25	6	NB1632ND25A
NB1 6kA 2P D32	6	NB1632ND32A
NB1 6kA 2P D40	6	NB1632ND40A
NB1 6kA 2P D50	6	NB1632ND50A
NB1 6kA 2P D63	6	NB1632ND63A

Kirjeldus	Pakend	Tootekood 6kA series
NB1 6kA 3P B6	4	NB1633NB6A
NB1 6kA 3P B10	4	NB1633NB10A
NB1 6kA 3P B13	4	NB1633NB13A
NB1 6kA 3P B16	4	NB1633NB16A
NB1 6kA 3P B20	4	NB1633NB20A
NB1 6kA 3P B25	4	NB1633NB25A
NB1 6kA 3P B32	4	NB1633NB32A
NB1 6kA 3P B40	4	NB1633NB40A
NB1 6kA 3P B50	4	NB1633NB50A
NB1 6kA 3P B63	4	NB1633NB63A
NB1 6kA 3P C1	4	NB1633NC1A
NB1 6kA 3P C2	4	NB1633NC2A
NB1 6kA 3P C3	4	NB1633NC3A
NB1 6kA 3P C4	4	NB1633NC4A
NB1 6kA 3P C6	4	NB1633NC6A
NB1 6kA 3P C10	4	NB1633NC10A
NB1 6kA 3P C13	4	NB1633NC13A
NB1 6kA 3P C16	4	NB1633NC16A
NB1 6kA 3P C20	4	NB1633NC20A
NB1 6kA 3P C25	4	NB1633NC25A
NB1 6kA 3P C32	4	NB1633NC32A
NB1 6kA 3P C40	4	NB1633NC40A
NB1 6kA 3P C50	4	NB1633NC50A
NB1 6kA 3P C63	4	NB1633NC63A
NB1 6kA 3P D4	4	NB1633ND4A
NB1 6kA 3P D6	4	NB1633ND6A
NB1 6kA 3P D10	4	NB1633ND10A
NB1 6kA 3P D13	4	NB1633ND13A
NB1 6kA 3P D16	4	NB1633ND16A
NB1 6kA 3P D20	4	NB1633ND20A
NB1 6kA 3P D25	4	NB1633ND25A
NB1 6kA 3P D32	4	NB1633ND32A
NB1 6kA 3P D40	4	NB1633ND40A
NB1 6kA 3P D50	4	NB1633ND50A
NB1 6kA 3P D63	4	NB1633ND63A
NB1-63DC 1P C10A DC250V 6kA	1	NB163DC1PC10A
NB1-63DC 1P C16A DC250V 6kA	1	NB163DC1PC16A
NB1-63DC 1P C32A DC250V 6kA	1	NB163DC1PC32A
NB1-63DC 1P C50A DC250V 6kA	1	NB163DC1PC50A
NB1-63DC 1P C63A DC250V 6kA	1	NB163DC1PC63A
NB1-63DC 2P C1A DC500V 6kA	1	NB163DC2PC1A
NB1-63DC 2P C2A DC500V 6kA	1	NB163DC2PC2A
NB1-63DC 2P C3A DC500V 6kA	1	NB163DC2PC3A
NB1-63DC 2P C4A DC500V 6kA	1	NB163DC2PC4A
NB1-63DC 2P C6A DC500V 6kA	1	NB163DC2PC6A
NB1-63DC 2P C10A DC500V 6kA	1	NB163DC2PC10A
NB1-63DC 2P C13A DC500V 6kA	1	NB163DC2PC13A
NB1-63DC 2P C16A DC500V 6kA	1	NB163DC2PC16A
NB1-63DC 2P C20A DC500V 6kA	1	NB163DC2PC20A
NB1-63DC 2P C25A DC500V 6kA	1	NB163DC2PC25A
NB1-63DC 2P C32A DC500V 6kA	1	NB163DC2PC32A
NB1-63DC 2P C40A DC500V 6kA	1	NB163DC2PC40A
NB1-63DC 2P C50A DC500V 6kA	1	NB163DC2PC50A
NB1-63DC 2P C63A DC500V 6kA	1	NB163DC2PC63A

S9 Töövoolulüliti mudelile NB1
V9 Alapingelüliti mudelile NB1
F9 Abiülüliti mudelile NB1



Rikkevoolulülitid NL1 ilma ülepingekaitseta (magnetlülitita)



NL1

Üldist

- 1.1 Kaitse tulekahju eest
- 1.2 Kaitse elektrilöögi vastu
- 1.3 3 vallandumisklassi: AC, A, LH
- 1.4 Vallandumisklassid
 - klass AC vallandumine toimub siinuslainelise AC-rikkevooluga, mis võib olla ootamatu või aeglaselt kasvav
 - klass A vallandumine toimub siinuslainelise AC-rikkevooluga ning impulsiise DC-rikkevooluga, mis võib olla ootamatu või aeglaselt kasvav
 - klass **S** võib kasutada ettepoole ühendatud rühmalülitina selektiivseks vallandumiseks, vastupidiselt järele ühendatud tavalisele maanduslekkelülitile
- 1.5 Rikkevoolu nimiväärtused
 - 30 mA – annab kõrge kaitsetaseme elektrilöögi vastu olukordades, kus on vaja lisakaitset otsese kokkupuute suhtes ja kui vallandumine peab toimuma 40 millisekundi jooksul, kui avastatud rikkevool on 150 mA. 100 mA – annab hea kaitsetaseme elektrilöögi vastu kaudse kokkupuute olukorras.
 - 300 mA – annab üldkaitse tulekahju vastu elektririkete, nt kaabeldusvigade korral, mille puhul piisav vool (üldjuhul alla 500 mA) võib põhjustada metalloosade ülekuumenemist teatud tingimustes, sest üldiselt kasutatud ülevoolukaitseesadmed vajavad vallandumiseks voolu tublisti üle 300 mA.
- 1.6 Rikkevooluindikaator

2. Tehnilised andmed

Standardid	IEC/EN 61008-1	
Tüüp (avastatud rikkevoolu laineline kuju)		AC, A, S
Nimivool, In	A	25, 40, 63, 80, 100
Klemmid		2P, 4P
Nimipinge, Ue	V	230/400
Nimitundlikkus In	A	0.03, 0.1, 0.3
Lühisvool Icn = Ic	V	6000/10000
Elektriline kasutusiga		2, 000
Mehaaniline kasutusiga		2, 000
Ühendusviis		juhe / hark-voolusiin / kammsiin
Kinnitus		DIN-siinile EN 60715 (35 mm) kiirkinnitusega
Ühendused		ülevalt ja alt

NL1

Kirjeldus	Pakend	Tootekood	Kirjeldus	Pakend	Tootekood
NL1 6KA 2P 40A 30mA A-TYPE	1	NL1632N30MAA40A	NL1 10kA 4P 40A 30mA A-TYPE	1	
NL1 6KA 2P 63A 30mA A-TYPE	1	NL1632N30MAA63A	NL1 10kA 4P 63A 30mA A-TYPE	1	
NL1 6KA 4P 40A 30mA A-TYPE	1	NL1634N30MAA40A	NL1 10kA 4P 100A 300mA A-TYPE	1	
NL1 6KA 4P 63A 30mA A-TYPE	1	NL1634N30MAA63A	NL1 6kA 2P 40A 30mA A-TYPE AUX	1	NL1632N30MAA40AX
NL1 6kA 2P 63A 300mA A-TYPE	1	NL1632N300MAA63A	NL1 6kA 4P 40A 30mA A-TYPE AUX	1	NL1634N30MAA40AX
NL1 6kA 4P 63A 300mA A-TYPE	1	NL1634N300MAA63A	NL1 6kA 2P 63A 30mA A-TYPE AUX	1	NL1632N300MAA63AX
NL1 10kA 2P 40A 30mA A-TYPE	1	NL1632N30MAA40A10K	NL1 6kA 4P 63A 30mA A-TYPE AUX	1	NL1634N30MAA63AX
NL1 10kA 2P 63A 30mA A-TYPE	1	NL1632N30MAA63A10K	NL1 6kA 4P 63A 300mA A-TYPE AUX	1	NL1634N300MAA63AX

NL210 Ülevoolukaitseta jäävoolulüliti



1. Üldinfo

- 1.1 Pakub kaitset isolatsioonivigastustest tingitud tulekahjuohu eest
- 1.2 Pakub kaitset elektrilöögi eest
- 1.3 B RCCB tüüpi lüliteid kasutatakse autolaadimisseadmetes, helioelektrisüsteemides, sagedusmuunduriga rakendustes, keevitussüsteemides ja nõudlikes kinnisvararakendustes

2. Tehnilised andmed

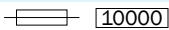
	Standard	IEC/EN 62423 & IEC/EN 61008-1
	Tüüp (tuvastatav maandusvoolu lainekuju)	B
	Nimivool	A 25, 40, 63
	Poolused	2P, 4P
	Nimipinge Ue	V 400
	Nimitundlikus I An	A 0.03
	Isolatsioonipinge Ui	V 500
	Laadimis- ja koguvoolu lahutusvõime I Am	A 500 (In=25A/40A) 630 (In=63A)
Elektrilised omadused	Lühisvool IncHAc	A 10,000
	SCPD kaitse	A  10000
	Katkestusaeg IΔn	S ≤0.1
	Nimisagedus	Hz 50/60
	Nimiimpulsi pingeline (1.2/50) Uimp	V 4,000
	Dielektriline kontrollpinge näidatud sagedusel 1 minuti jooksul	kV 2.5
	Saasteklass	2
Mehaanilised omadused	Elektriliste osade elukaar	2, 000
	Mehaaniliste osade elukaar	10,000
	Rikkevoolunäidik	Yes
	Kaitseklass	IP20
	Keskonnatemperatuur (päevase keskmise < 35 °C korral)	°C -25...+40
Säilitustemperatuur	°C -25...+70	
	Klemmide ühenduste tüüp	Juhe / U-tüüpi siin / Kontaktühendusega
Paigaldamine	Ülemise/alumise klemmi suurus juhtme ühendamiseks	mm ² 25/35 AWG 18-3/18-2
	Ülemise/alumise klemmi suurus siini ühendamiseks	mm ² 10/16 AWG 18-8/18-5
	Pöördemoment	N-m 2.5 In-lbs. 22
	Paigaldus	DIN relsile EN 60715 (35mm) kiirkinnitusklambrite abil
	Ühendus	Ülevalt ja alt

Andmed	Tootekood	Pakend
NL210 1PN 25A 30mA B 10kA	NL2102N30MAB25A	1
NL210 1PN 40A 30mA B 10kA	NL2102N30MAB40A	1
NL210 1PN 63A 30mA B 10kA	NL2102N30MAB63A	1
NL210 3PN 25A 30mA B 10kA	NL2104N30MAB25A	1
NL210 3PN 40A 30mA B 10kA	NL2104N30MAB40A	1
NL210 3PN 63A 30mA B 10kA	NL2104N30MAB63A	1



Rikkevoolulülitid ülevoolukaitsega NB1L (magnetlüliti)

1. Üldist

- 1.1 Kaitse tulekahju eest
- 1.2 Kaitse elektrilöögi vastu
- 1.3 Ülekoormuskaitse
- 1.4 Lühisekaitse
- 1.5 Lülite asendi indikaator

	Standardi	IEC/EN 61009-1
	Nimivool	A 6, 10, 16, 20, 25
Tehnilised andmed	Liigitatud vastavalt kiirvallandumistüübile	Tüüp B:(3...5) In, Tüüp C: (5...10) In
	Klemmijuhthmed	1P+N
	Tüüp (avastatud maanduslekke laineline kuju)	Tüüp AC, Tüüp A
	Nimipinge Ue	V AC240
	Korpuse nimivool Inm	A 25
	Nimivallandumisvool Δn	A 0,03
	Nimitaluvusvool Δno	A 0,015
Tehnilised parameetrid	Nominaalne lühise katkestamise võime Icn	A 4500
	Nominaalne rikkevoolu ühendamis- ja katkestamisvõime I Δ m	A 500
	Elektriline kestus	2,000
	Mehaaniline kestus	2,000
	Nominaalne impulsspingetaluvus Uimp	V 6,000

2. Tehnilised andmed



NB1L



NB310L

Standardid	IEC/EN 61009-1	
Vallandumistüüp (avastatud rikkevoolu laineline kuju)	AC,A	
Termomagnetlüliti karakteristikud	B, C	
Nimivool In	A	Kaitseüliti + rikkevoolukaitse moodul 1, 2, 3, 4, 6, 10, 13, 16, 20, 25, 32, 40, 50, 63
		Kombineeritud 1, 2, 3, 4, 6, 10, 13, 16, 20, 25, 32, 40
Klemmid		Kaitseüliti + rikkevoolukaitse moodul 1P+N, 2P, 3P, 3P+N, 4P
		Kombineeritud 1P+N, 2P
Nimipinge Ue	V	230/400
Nimitundlikkus IΔn	A	Kaitseüliti + rikkevoolukaitse moodul 0.03, 0.1, 0.3
		Kombineeritud 0.03
Nominaalne lühise katkestamise võime Icn	A	6,000/10,000
Katkestusaeg väärtusel IΔn	S	≤0.1
Elektriline kasutusiga		2,000
Mehaaniline kasutusiga		2,000
Kinnitus		DIN-siinile EN 60715 (35 mm) kiirkinnitusega
Ühendused		ülevalt ja alt (kombineeritud seadmed)
		ülevalt (kaitseüliti + rikkevoolukaitse moodul)

4. Välismõõtmed ja kinnitusmõõtmed (mm)

Kaitselüliti + rikkevoolukaitse moodul

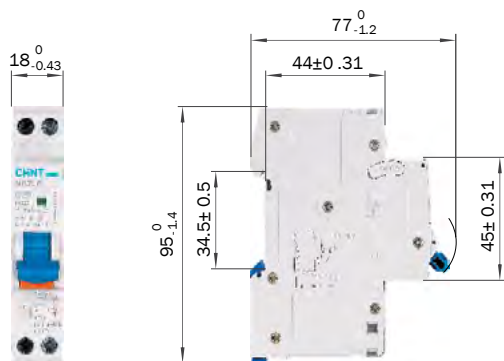

Välismõõtmed ja kinnitusmõõtmed

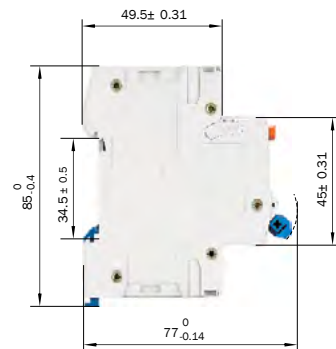

Combined

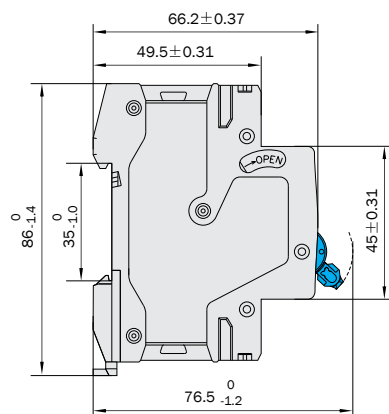
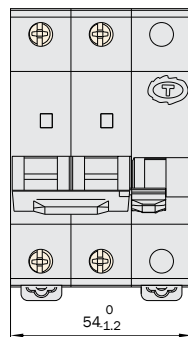
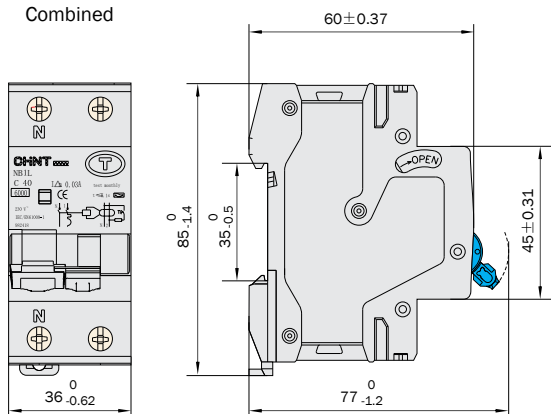

Rikkevoolulülid ülevoolukaitsega

Kirjeldus	Pakend	Tootekood
NB2LE (18mm): elektrooniline rikkevoolu tuvastamine	1	
NB2LE 1P+N B6 30mA A 4,5kA	1	NB2LE1PN30MAA6B
NB2LE 1P+N B10 30mA A 4,5kA	1	NB2LE1PN30MAA10B
NB2LE 1P+N B16 30mA A 4,5kA	1	NB2LE1PN30MAA16B
NB2LE 1P+N B20 30mA A 4,5kA	1	NB2LE1PN30MAA20B
NB2LE 1P+N B25 30mA A 4,5kA	1	NB2LE1PN30MAA25B
NB2LE 1P+N C6 30mA A 4,5kA	1	NB2LE1PN30MAA6C
NB2LE 1P+N C10 30mA A 4,5kA	1	NB2LE1PN30MAA10C
NB2LE 1P+N C16 30mA A 4,5kA	1	NB2LE1PN30MAA16C
NB2LE 1P+N C20 30mA A 4,5kA	1	NB2LE1PN30MAA20C
NB2LE 1P+N C25 30mA A 4,5kA	1	NB2LE1PN30MAA25C
NB1L (36mm): magnetilise rikke tuvastamine	1	
NB1L 1P+N B2 30mA A 6KA (kombineeritud)	1	NB1L1PN30MAA2B
NB1L 1P+N B3 30mA A 6KA (kombineeritud)	1	NB1L1PN30MAA3B
NB1L 1P+N B4 30mA A 6KA (kombineeritud)	1	NB1L1PN30MAA4B
NB1L 1P+N B6 30mA A 6KA (kombineeritud)	1	NB1L1PN30MAA6B
NB1L 1P+N B10 30mA A 6KA (kombineeritud)	1	NB1L1PN30MAA10B
NB1L 1P+N B13 30mA A 6KA (kombineeritud)	1	NB1L1PN30MAA13B
NB1L 1P+N B16 30mA A 6KA (kombineeritud)	1	NB1L1PN30MAA16B
NB1L 1P+N B20 30mA A 6KA (kombineeritud)	1	NB1L1PN30MAA20B
NB1L 1P+N B25 30mA A 6KA (kombineeritud)	1	NB1L1PN30MAA25B
NB1L 1P+N C1 30mA A 6KA (kombineeritud)	1	NB1L1PN30MAA1C
NB1L 1P+N C2 30mA A 6KA (kombineeritud)	1	NB1L1PN30MAA2C
NB1L 1P+N C3 30mA A 6KA (kombineeritud)	1	NB1L1PN30MAA3C
NB1L 1P+N C4 30mA A 6KA (kombineeritud)	1	NB1L1PN30MAA4C
NB1L 1P+N C6 30mA A 6KA (kombineeritud)	1	NB1L1PN30MAA6C
NB1L 1P+N C10 30mA A 6KA (kombineeritud)	1	NB1L1PN30MAA10C
NB1L 1P+N C13 30mA A 6KA (kombineeritud)	1	NB1L1PN30MAA13C
NB1L 1P+N C16 30mA A 6KA (kombineeritud)	1	NB1L1PN30MAA16C

Kirjeldus	Pakend	Tootekood
NB1L 1P+N C20 30mA A 6KA (kombineeritud)	1	NB1L1PN30MAA20C
NB1L 1P+N C25 30mA A 6KA (kombineeritud)	1	NB1L1PN30MAA25C
NB310L (72mm): magnetilise rikke tuvastamine	1	
NB310L/3N 3P+N C6 30mA A TYPE 6kA	1	NB310L3PN30MAA6C
NB310L/3N 3P+N C10 30mA A TYPE 6kA	1	NB310L3PN30MAA10C
NB310L/3N 3P+N C13 30mA A TYPE 6kA	1	NB310L3PN30MAA13C
NB310L/3N 3P+N C16 30mA A TYPE 6kA	1	NB310L3PN30MAA16C
NB310L/3N 3P+N C20 30mA A TYPE 6kA	1	NB310L3PN30MAA20C
NB310L/3N 3P+N C25 30mA A TYPE 6kA	1	NB310L3PN30MAA25C
NB310L/3N 3P+N C32 30mA A TYPE 6kA	1	NB310L3PN30MAA32C
NB310L/3N 3P+N C40 30mA A TYPE 6kA	1	NB310L3PN30MAA40C



Seadistatavate vallandumisväärtustega kompaktlülitid NM8



NM8

- Nimivoolud vahemikus 16...1600 A
- Mudelid termomagnetilise / elektroonilise / vaid termilise vallandumisega
- Seadistatav termiline ja seadistatav magnetiline vallandumine
- Saadaval 2-, 3- ja 4-klemmiga mudelid
- Sobivad AC/DC-kasutuseks
- 5 katkestusvõime klassi, vahemikus 25...150 kA
- Ics = 100% Icu (In 630 A), Ics = 150% Icu (In > 630 A)
- Kaitselülitiid ja abilülitiid vastavad järgmistele rahvusvahelistele standarditele:
IEC/EN 60947-1: üldeeskirjad
IEC/EN 60947-2: kaitselülitiid
IEC/EN 60947-3: lülitiid, katkestid, koormuslahklülitiid jne
IEC/EN 60947-4: kontaktorid ja mootorikäivitiid
IEC/EN 60947-5.1 ja järgmised: juhtahela seadmed ja ühendustarvikud, automaatsed juhtkomponendiid
- NM8-seeria vastab ka meresõidu sertifitseerimisasutuste eeskirjadele
- Sertifitseeritud kasutamiseks III määrdumisastme keskkonnas, järgides standardit IEC 60947 (tööstuskeskkonnad)
- Lai temperatuuride vahemik -40...+70 °C
- NM8-seeriale on pakkuuda täisvalik lisamooduleid

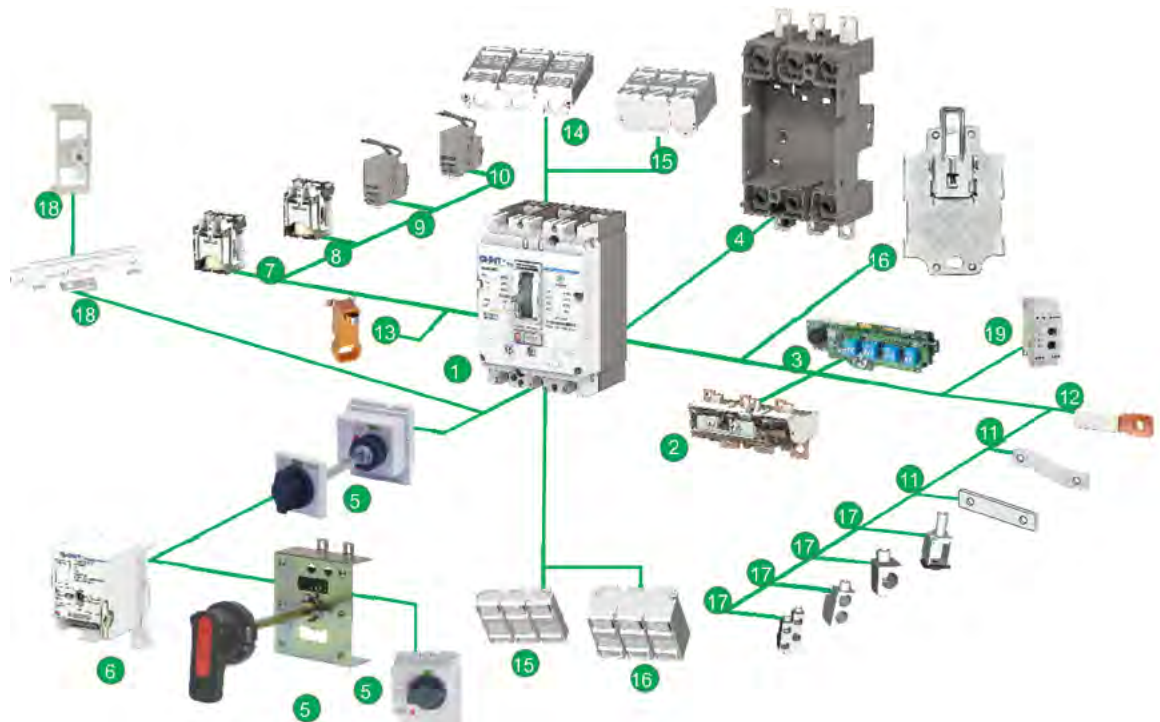

- 1 Korpused
- 2 Termo-magnetlüliti
- 3 Elektrooniline vallandusseade
- 4 Plug-in-alusplaat
- 5 Manuaalse kasutamise nupp

- 6 Mootoriga käitumehhanism
- 7 Alapingelüliti
- 8 Töövoolulüliti
- 9 Häirenupp
- 10 Abilüliti

- 11 Eespoolsed liitmikud
- 12 Tagapoolsed liitmikud
- 13 Lukustusasaas (tabalukule)
- 14 Madal ühenduskaas
- 15 Kõrge ühenduskaas

- 16 DIN-siini adapter
- 17 Surveliitmik
- 18 Mehaaniline lukustus
- 19 Andmeedastusmoodul

Välismõõtmed ja kinnitusmõõdud püsimudelitele, liitmikud eest

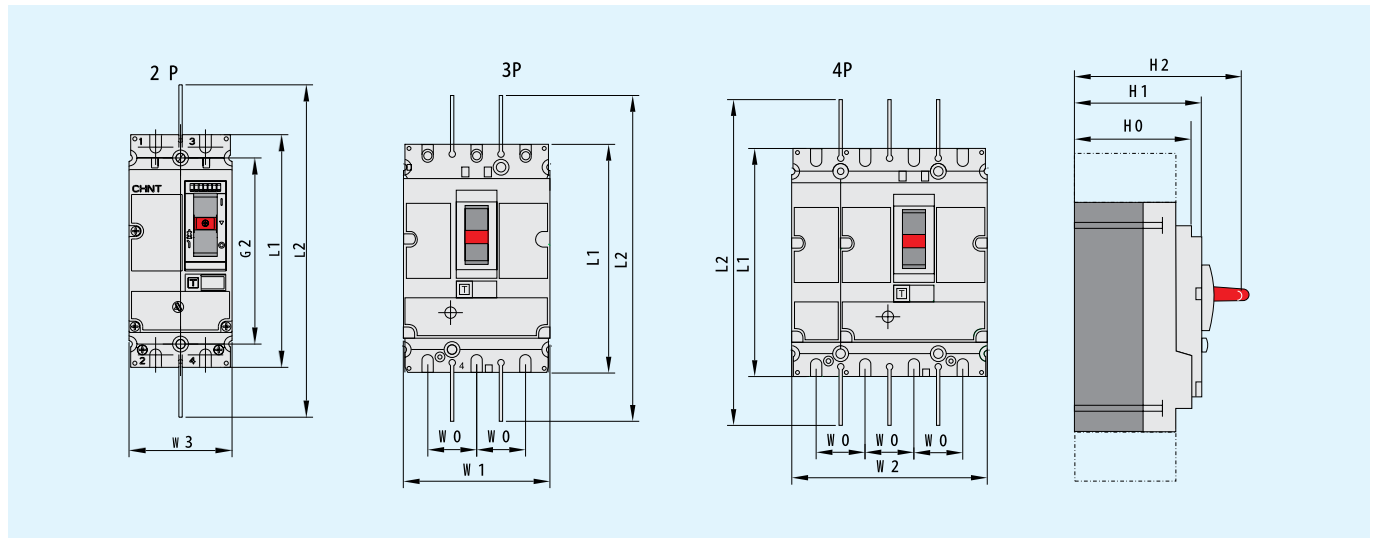

	L1	L2	H0	H1	H2	K	K1	K2	G1	G2	W0	W1	W2	W3	d
NM8-125	140	240	72	79	103	15	30	60	56	112	30	90	120	62	6
NM8S-125/NM8-250/NM8S-250	157	357	82	88	126	17,5	35	70	62,5	125	35	105	140	70	6
NM8-400, 630/NM8S-400, 630	255	474	95	113	168	22,5	45	90	100	200	45	140	185	-	6
NM8-800, 1250/NM8S-800, 1250	370	570	132	144	206	35	70	140	120	240	70	210	280	-	7

Kirjeldus	Tootekood	Pakend
3-klemmiga 16-125 A		
NM8-125S 3P 16A	NM8125S3P16A	1
NM8-125S 3P 20A	NM8125S3P20A	1
NM8-125S 3P 25A	NM8125S3P25A	1
NM8-125S 3P 32A	NM8125S3P32A	1
NM8-125S 3P 40A	NM8125S3P40A	1
NM8-125S 3P 50A	NM8125S3P50A	1
NM8-125S 3P 63A	NM8125S3P63A	1
NM8-125S 3P 80A	NM8125S3P80A	1
NM8-125S 3P 100A	NM8125S3P100A	1
NM8-125S 3P 125A	NM8125S3P125A	1
3-klemmiga 100-250 A		
NM8-250S 3P 100A	NM8250S3P100A	1
NM8-250S 3P 125A	NM8250S3P125A	1
NM8-250S 3P 160A	NM8250S3P160A	1
NM8-250S 3P 180A	NM8250S3P180A	1
NM8-250S 3P 200A	NM8250S3P200A	1
NM8-250S 3P 225A	NM8250S3P225A	1
NM8-250S 3P 250A	NM8250S3P250A	1
3-klemmiga 250-400 A		
NM8-400S 3P 250A	NM8400S3P250A	1
NM8-400S 3P 315A	NM8400S3P315A	1
NM8-400S 3P 350A	NM8400S3P350A	1
NM8-400S 3P 400A	NM8400S3P400A	1
3-klemmiga 250-630 A		
NM8-630S 3P 250A	NM8630S3P250A	1
NM8-630S 3P 315A	NM8630S3P315A	1
NM8-630S 3P 350A	NM8630S3P350A	1
NM8-630S 3P 400A	NM8630S3P400A	1
NM8-630S 3P 500A	NM8630S3P500A	1
NM8S-630S 3P 630A	NM8S630S3P630A	1
3-klemmiga 630-800 A		
NM8S-1250S 3P 800A	NM8S1250S3P800A	1
NMBS-1250S 3P 1000A	NMBS1250S3P1000A	1
NMBS-1250S 3P 1250A	NMBS1250S3P1250A	1
3-klemmiga 1250-1600 A		
NM8S-1600S 3P 1250A	NM8S1600S3P1250A	1
NM8S-1600S 3P 1600A	NM8S1600S3P1600A	1

Kirjeldus	Tootekood	Pakend
4-klemmiga 16-125 A		
NM8-125S 4P 16A	NM8125S4P16A	1
NM8-125S 4P 20A	NM8125S4P20A	1
NM8-125S 4P 25A	NM8125S4P25A	1
NM8-125S 4P 32A	NM8125S4P32A	1
NM8-125S 4P 40A	NM8125S4P40A	1
NM8-125S 4P 50A	NM8125S4P50A	1
NM8-125S 4P 63A	NM8125S4P63A	1
NM8-125S 4P 80A	NM8125S4P80A	1
NM8-125S 4P 100A	NM8125S4P100A	1
NM8-125S 4P 125A	NM8125S4P125A	1
4-klemmiga 100-250 A		
NM8-250S 4P 100A	NM8250S4P100A	1
NM8-250S 4P 125A	NM8250S4P125A	1
NM8-250S 4P 160A	NM8250S4P160A	1
NM8-250S 4P 180A	NM8250S4P180A	1
NM8-250S 4P 200A	NM8250S4P200A	1
NM8-250S 4P 225A	NM8250S4P225A	1
NM8-250S 4P 250A	NM8250S4P 250A	1
4-klemmiga 250-400		
NM8-400S 4P 250A	NM8400S4P250A	1
NM8-400S 4P 315A	NM8400S4P315A	1
NM8-400S 4P 350A	NM8400S4P350A	1
NM8-400S 4P 400A	NM8400S4P400A	1
4-klemmiga 250-630 A		
NM8-630S 4P 250A	NM8630S4P250A	1
NM8-630S 4P 315A	NM8630S4P315A	1
NM8-630S 4P 350A	NM8630S4P350A	1
NM8-630S 4P 400A	NM8630S4P400A	1
NM8-630S 4P 500A	NM8630S4P500A	1
NM8S-630S 4P 630A	NM8S630S4P630A	1
4-klemmiga 630-800 A		
NM8S-1250S 4P 800A	NM8S1250S4P800A	1
NMBS-1250S 4P 1000A	NMBS1250S4P1000A	1
NMBS-1250S 4P 1250A	NMBS1250S4P1250A	1
4-klemmiga 1250-1600 A		
NM8S-1600S 4P 1250A	NM8S1600S4P1250A	1
NM8S-1600S 4P 1600A	NM8S1600S4P1600A	1

Kompaktlülititele on saada laias valikus lisatarvikuid. Küsige lisa meie klienditeenindusest.

Tehnilised andmed

Parameetrid

Kaitselülitid NM8 (termomagnetiiline vallandumine)		NM8-125						NM8-250					
4 korpuse suurus		korpuse suurus 1						korpuse suurus 2					
Elektrilised väärtused vastavalt standarditele IEC 6094 7-2 ja EN6094 7-2													
Nimivool (A) In		16, 20, 25, 32, 40, 50, 63, 80, 100, 125						100, 125, 160, 180, 200, 225, 250					
Nimiisolatsioonipinge (V) Ui		750						750					
Impulsspinge taluvus, nimiväärtus (k V) Uimp		8						8					
Nimipinge	Ue	AC 50V/60Hz						690					
		DC						500					
Klemmid		2		3		4		2		3		4	
													
Lahutusvõime liigitus		H	S	H	R	S	H	H	S	H	R	S	H
Nominaalne lühise katkestamise võime (kA RMS) Icu	AC 220V/230V/2 40V	100	85	100	150	85	100	100	85	100	150	85	100
	AC 380V/400V/415 V	100	50	100	150	50	100	100	50	100	150	50	100
	AC 440V	100	50	100	130	50	100	100	50	100	130	50	100
	AC 500V	50	35	50	70	35	50	50	35	50	70	35	50
	AC 660V/690V	6	5	6	8	5	6	8	6	8	10	6	8
	DC 250V (1P)	35	25	35	50	25	35	35	25	35	50	25	35
DC 500V (2P)	35	25	35	50	25	35	35	25	35	50	25	35	
Nominaalne lahutusvõime kasutussuhe Ics = (%Icu)		100						100					
Sobib lahkliitiks		■						■					
Kasutuskategooria		A						A					
Turvaline isolatsioon		■						■					
Kasutusiga (töökordi)	Mehaaniline	20,000						20,000					
	Elektriline	20,000						20,000					
Kaitsefunktsioon		termomagnetiiline						termomagnetiiline					
Vallandusüksused		■						■					
Ülekoormuskaitse		■						■					
Lühisekaitse		■						■					
Rikkevoolukaitse	Eraldi rikkevoolukaitse moodul	■						■					
Kinnitus ja ühendused													
Statsionaarne	Ühendus eest	■						■					
	Ühendus tagant	■						■					
DIN-siin	Ühendus eest	■						■					
	Ühendus tagant	■						■					
Plug-in-mudel	Ühendus eest	■						■					
	Ühendus tagant	■						■					
Juhtimise ja kontrollimise abilülid		■						■					
Manuaalne	Nupp otse või pikendusvarrega	■						■					
		■						■					
Mootorkäitusega mehhanism		■						■					
Manuaalne, kaugjuhitav, automaatne toite vahetamine		■						■					
Töövoolu ja alapinge lüliti		■						■					
Abilüliti ja häirelüliti		■						■					
Tabaluku kinnitamise võimalus		■						■					
Kinnitus- ja ühendustarvikud													
Ühendussegment		■						■					
Ühendusaas ette		■						■					
Ühendusaas taha		■						■					
DIN-siini adapter		■						■					
Plug-in-mudeli ühendustarvikud		■						■					
Liitmike kaitsed		■						■					
Faaside isolatsiooniplaadid		■						■					
Mõõtmed ja mass		■						■					

NM8-400			NM8-630			NM8-800			NM8-1250			NM8S-1600					
korpuse suurus 3						korpuse suurus 4											
250, 315, 350, 400			250, 315, 350, 400, 500			630, 700, 800			800, 1000, 1250			610, 700, 800, 1000, 1250, 1600					
750			750			750			750			750					
8			8			8			8			8					
690			690			690			690			690					
500			500			500			500			-					
2		4		2		4		3		4		3		4			
S	H	R	S	H	S	H	R	S	H	S	H	R	S	H	S	H	
85	100	150	85	100	85	100	150	85	100	65	100	-	65	100	65	100	
70	100	150	70	100	70	100	150	70	100	50	70	-	50	70	50	70	
50	85	130	50	85	50	85	130	50	85	35	65	-	35	65	35	65	
35	50	70	35	50	35	50	70	35	50	30	50	-	30	50	30	50	
10	12	15	10	12	10	12	15	10	12	10	20	-	10	20	10	20	
25	35	50	25	35	25	35	50	25	35	35	50	-	35	50	35	50	
25	35	50	25	35	25	35	50	25	35	35	50	-	35	50	35	50	
100 □			100 □			50			50			50					
■			■			■			■			■					
A			A			A			A			A					
■			■			■			■			■					
15,000			15,000			15,000			15,000			15,000					
6000			4000			4000			4000			4000					
termomagnetiline			termomagnetiline			termomagnetiline			termomagnetiline			termomagnetiline					
■			■			■			■			■					
■			■			■			■			■					
■			■			-			-			■					
■			■			-			-			-					
■			■			-			-			-					
■			■			-			-			-					
■			■			-			-			-					
■			■			■			■			-					
■			■			-			-			■					
■			■			-			-			■					
■			■			-			-			■					
■			■			-			-			■					
■			■			-			-			-					
■			■			-			-			-					
■			■			-			-			-					
■			■			-			-			-					
■			■			-			-			-					
■			■			■			■			-					
■			■			-			-			-					
■			■			-			-			-					
■			■			-			-			-					
■			■			-			-			-					
■			■			-			-			-					
■			■			-			-			-					
■			■			-			-			-					
■			■			-			-			-					



NA8G

Õhklülitid NA8G

- Nimivool vahemikus 200... 6300 A
- Suurim lahutusvõime 120 kA @ 400 V
- Saadaval 3- ja 4-klemmiga mudelid
- Väljatõmmatavad ja püsipaigaldusega mudelid
- Kaitserelees ja maanduslühise kaitse standardvarustuses
- Vastavad standardile IEC/ EN 60947-2
- Temperatuuride vahemik -5...+40 °C
- Täielik valik lisatarvikuid

Täielik valik lisavarustust



Kinnijuhtimispool



Töövoolupool



Mehaaniline lukustus
trossiga



Ukse lukustus



Alapingepool



Väljatõmmatav mudel



Mehaaniline
lukustus varrastega



Vedrude häälestusmootor



Kaitserelee



Abilülitid



Võtmega lukk



Faaside
isolatsiooniplaadid

Tutvustus

Korpused kolmes suuruses



NA8G-1600 200, 400, 630, 800, 1000, 1250, 1600



NA8G-3200 1600, 2000, 2500, 2900, 3200



NA8G-6300 4000, 5000, 6300

Kaitserellee M-mudel



- Kaitsefunktsioonid: ülekoormuskaitse, selektiivne lühisekaitse, lühise kiirvallandus, maanduslühise kaitse
- Voolutugevuse mõõtmine
- Testimisfunktsioonid
- Vigade salvestamise funktsioon
- Automaatne diagnoosimine
- MCR ühendus- ja lahutusfunktsioon
- 33 x 22 LCD-ekraan

Kaitserellee H-mudel



- Kaitsefunktsioonid: ülekoormuskaitse, selektiivne lühisekaitse, lühise kiirvallandus, maanduslühise kaitse
- Voolutugevuse, võimsuse, energia ja harmooniliste kõrglainete mõõtmine
- Testimisfunktsioonid
- Vigade salvestamise funktsioon
- Automaatne diagnoosimine
- MCR ühendus- ja lahutusfunktsioon
- Kommunikatsioonifunktsioonid (nt MODBUS)
- Tööaja salvestamine
- Klemmide seisukorra kontroll
- Kasutuskordade salvestamine
- 28 x 43 LCD-ekraan

Kirjeldus	Tootekood
Manuaalsed ja püsipaigaldusega mudelid	
3-klemmiga	
NA8G-1600-200M/3 Manual&Fix	
NA8G-1600-400M/3 Manual&Fix	
NA8G-1600-630M/3 Manual&Fix	
NA8G-1600-800M/3 Manual&Fix	
NA8G-1600-1000M/3 Manual&Fix	NA8G1610M3F
NA8G-1600-1250M/3 Manual&Fix	NA8G1612M3F
NA8G-1600-1600M/3 Manual&Fix	NA8G1616M3F
NA8G-3200-2000M/3 Manual&Fix	NA8G1620M3F
NA8G-3200-2500M/3 Manual&Fix	NA8G1625M3F
NA8G-3200-3200M/3 Manual&Fix	NA8G3232M3F
4-klemmiga	
NA8G-1600-200M/4 Manual&Fix	
NA8G-1600-400M/4 Manual&Fix	
NA8G-1600-630M/4 Manual&Fix	
NA8G-1600-800M/4 Manual&Fix	NA8G1680M4MF
NA8G-1600-1000M/4 Manual&Fix	NA8G1610M4MF
NA8G-1600-1250M/4 Manual&Fix	NA8G1612M4MF
NA8G-1600-1600M/4 Manual&Fix	NA8G1616M4MF
NA8G-3200-2000M/4 Manual&Fix	
NA8G-3200-2500M/4 Manual&Fix	
NA8G-3200-3200M/4 Manual&Fix	NA8G3220M3MF

Kirjeldus	Tootekood
Mootoriga ja väljatõmmatavad mudelid	
3-klemmiga	
NA8G-1600-200M/3 Motor&Drawer	
NA8G-1600-400M/3 Motor&Drawer	
NA8G-1600-630M/3 Motor&Drawer	
NA8G-1600-800M/3 Motor&Drawer	NA8G1680M3MD230
NA8G-1600-1000M/3 Motor&Drawer	NA8G1610M3MD230
NA8G-1600-1250M/3 Motor&Drawer	NA8G1612M3MD230
NA8G-1600-1600M/3 Motor&Drawer	NA8G1616M3MD230
NA8G-3200-2000M/3 Motor&Drawer	NA8G3220M3MD230
NA8G-3200-2500M/3 Motor&Drawer	NA8G3225M3MD230
NA8G-3200-3200M/3 Motor&Drawer	NA8G3232M4MD230
NA8G-6300-4000M/3P Motor&Drawer	
NA8G-6300-5000M/3P Motor&Drawer	
4-klemmiga	
NA8G-1600-200M/4 Motor&Drawer	
NA8G-1600-400M/4 Motor&Drawer	
NA8G-1600-630M/4 Motor&Drawer	
NA8G-1600-800M/4 Motor&Drawer	NA8G1680M4MD230
NA8G-1600-1000M/4 Motor&Drawer	NA8G1610M4MD230
NA8G-1600-1250M/4 Motor&Drawer	NA8G1612M4MD230
NA8G-1600-1600M/4 Motor&Drawer	NA8G1616M4MD230
NA8G-3200-2000M/4 Motor&Drawer	NA8G3220M4MD230
NA8G-3200-2500M/4 Motor&Drawer	NA8G3225M4MD230
NA8G-3200-3200M/4 Motor&Drawer	NA8G3232M4MD230

Õhklülititele on saada laias valikus lisatarvikuid. Küsige lisa meie klienditeenindusest.



Väikekontaktorid NC6



NC6

NC6-seeria kontaktoreid kasutatakse mootorite (4 kW) kaugjuhtimisrakendustes.

Väärtused kuni 690 V, 9 A (AC3)(6 A, 9 A)

Standardid: IEC/EN 60947-4-1

Saada kahte liiki kinnitusega: Normaalne (ilma ühendustihvtideta); tihvtidega (ühendustihvtidega)

Keskkonna temperatuur: -5 °C ... +40 °C

Pooli pinge (AC): 24 V, 36 V, 48 V, 110 V, 127 V, 220 V, 230 V, 380 V, 400 V;

Abilülitid: NCF6-02 & NCF6-20 (2NO või 2NC)
NCF6-13 & NCF6-31 (1NO & 3NC või 3NO & 1NC)
NCF6-13 & NCF6-31 (4NO või 4NC)

- Ühendades kontaktoriga termorelee NR2-11.5, tekib otsekäiviti



Kontaktorid NC1



NC1

NC1-seeria kontaktoreid kasutatakse mootorite (45 kW) kaugjuhtimisrakendustes.

Väärtused on kuni 690 V, 95 A (AC3) (9 A, 12 A, 18 A, 25 A, 32 A, 40 A, 50 A, 65 A, 80 A, 95 A)

Standardid: IEC/EN 60947-4-1

Keskkonna temperatuur: -5 °C ... +40 °C

Pooli pinge (AC): 24 V, 36 V, 48 V, 110 V, 127 V, 220 V, 230 V, 380 V, 415 V, 440 V, 480 V, 500 V, 600 V, 660 V

Pooli pinge (DC): 24 V, 36 V, 48 V, 110 V, 220 V

Küljele paigaldatavad abilülitid: NCF1-11C (1NO & 1NC)
Peale paigaldatavad abilülitid: F4-20 & F4-02 (2NO & 2NC)
F4-13 & F4-31 (1NO & 3NC tai 3NO & 1NC)
F4-40 & F4-04 (4NO tai 4NC)

Peale paigaldatavad aeglustusajamoodulid: F5-T (tõmbe aeglustus)
F5-D (vallandumise aeglustus)

- Ristlukustusvahendid tähe/kolmnurga käivitamiseks ja tagurdamiseks



Kontaktorid NC2



NC2

Väärtused alati kuni 690 V, 630 A (AC3). -- (115 A, 150 A, 185 A, 225 A, 265 A, 330 A, 400 A, 500 A, 630 A)

Standardid: IEC/EN 60947-4-1

Keskkonna temperatuur: -5 °C ... +40 °C

Pooli pinge (AC): 110 V, 127 V, 220 V, 230 V, 380 V, 400 V;

Peale paigaldatavad abilülitid: F4-20 & F4-02 (2NO & 2NC)
F4-13 & F4-31 (1NO & 3NC tai 3NO & 1NC)
F4-40 & F4-04 (4NO tai 4NC)

Peale paigaldatavad aeglustusajamoodulid: F5-T (tõmbe aeglustus)
F5-D (vallandumise aeglustus)



Moodularvestusega AC-kontaktorid NCH8

1. Üldist

1.1 Sertifikaadid

- NCH8-20: CE, SEMKO, ESC
- NCH8-63: CE

1.2 **Elektrilised väärtused:** 20 A, 40 A, 63 A, 24 VAC, 230 V, 50/60 Hz AC

1.3 **Kasutuskategooriad:** AC-1, AC-7a, AC-7b

1.4 **Standardid:** IEC/EN 61095









NCH8

Kontaktorid

Tehnilised andmed

★ AC pool

Omadus	Mudel	NC1-09	NC1-12	NC1-18	NC1-25	
Korpuse suurus		Korpus 1 (3 ja 4 klemmiga)		Korpus 2 (3 klemmiga)	Korpus 3 (3 ja 4 klemmiga)	
						
Termiline nimivool (A) AC-1		20	20	32	40	
Nimivool (A)	380/400V	AC-3	9	12	18	25
		AC-4	3,5	5	7,7	8,5
	660/690V	AC-3	6,6	8,9	12	18
		AC-4	1,5	2	3,8	4,4
Nimiisolatsioonipinge (V AC)		690	690	690	690	
3-faasilise mootori nimipinge (AC-3)	kW	220/230V AC	2,2	3	4	5,5
		380/400V AC	4	5,5	7,5	11
		660/690V AC	5,5	7,5	10	15
	hv	200V AC	3	5	7,5	7,5
		240V AC	3	5	7,5	10
		460V AC	5	7,5	10	15
600V AC	5	7,5	10	15		
Töösagedus (töökorda tunnis)	Elektriline	AC-3	1,200	1,200	1,200	1,200
		AC-4	300	300	300	300
	Mehaaniline	3,600	3,600	3,600	3,600	
Elektriline kasutusiga (x 10 ³ töökorda)	AC-3	1,000	1,000	1,000	1,000	
	AC-4	200	200	200	200	
Mehaaniline kasutusiga (x 10 ³ töökorda)		10	10	10	10	
Sobiv kaitse		RT 16-20	RT 16-20	RT16-32	RT16-40	

NC1-32	NC1-40	NC1-50	NC1-65	NC1-80	NC1-95
Korpus 4 (3 klemmiga)	Korpus 5 (3 ja 4 klemmiga)			Korpus 6 (3 ja 4 klemmiga)	
					
50	60	80	80	95	95
32	40	50	65	80	95
12	18,5	24	28	37	44
21	34	39	42	49	49
7,5	9	12	14	17,3	21,3
690	690	690	690	690	690
7,5	11	15	18,5	22	25
15	18,5	22	30	37	45
18,5	30	37	37	45	45
10	15	15	20	25	30
15	20	20	25	30	30
20	25	30	40	40	50
20	25	30	40	40	50
600	600	600	600	600	600
300	300	300	300	300	300
3,600	3,600	3,600	3,600	3,600	3,600
800	800	600	600	600	600
200	150	150	150	100	100
8	8	8	8	6	6
RT16-50	RT16-63	RT16-80	RT16-80	RT16-100	RT16-125

Tehnilised andmed

★ 3 klemmiga kontaktorid AC-pooliga

Mudel			NC2-115	NC2-150	NC2-185
Terminiline nimivool (A) AC-1			200	200	275
Nimivool (A)	AC-3 AC-4	380/400V AC	115	150	185
		660/690V AC	86	108	118
		1000V AC	46	50	71
3-faasilise mootori nimivõimsus (AC-3)	kW	380/400V AC	55	75	90
		660/690V AC	80	100	110
		1000V AC	65	65	100
	hp	240V AC	40	50	60
		415V AC	60	75	100
		480V AC	75	100	100
600V AC	75	100	100		
Kasutussagedus (töökorda tunnis) AC-3			1,200	1,200	600
Elektriline kasutusiga (x 10 ⁶ töökorda) (AC-3)			1,2	1,2	1
Mehaaniline kasutusiga (x 10 ⁶ töökorda)			10	10	6
Sobiv	Mudel		RT16-1	RT16-1	RT16-2
Kaitse	Nimivool (A)		200	225	315

★ 4 klemmiga kontaktorid AC-pooliga

Mudel			NC2-115	NC2-150	NC2-185
Korpuse suurus					Korpus 2
Terminiline nimivool (A)			200	200	275
Nimivool (A)	AC-3 AC-4	380/400V AC	115	150	185
		660/690V AC	86	108	118
		1000V AC	46	50	71
3-faasilise mootori nimivõimsus (AC-3)	kW	380/400V AC	55	75	90
		660/690V AC	80	100	110
		1000V AC	65	65	100
	hp	240V AC	40	50	60
		415V AC	60	75	100
		480V AC	75	100	100
600V AC	75	100	100		
Kasutussagedus (töökorda tunnis) AC-3			1,200	1,200	600
Elektriline kasutusiga (x 10 ⁶ töökorda) (AC-3)			1,2	1,2	1
Mehaaniline kasutusiga (x 10 ⁶ töökorda)			10	10	6
Sobiv	Mudel		RT16-1	RT16-1	RT16-2
Kaitse	Nimivool (A)		200	225	315







NC2-225	NC2-265	NC2-330	NC2-400	NC2-500	NC2-630
275	315	380	450	630	800
225	265	330	400	500	630
137	170	235	303	353	462
90	112	155	200	232	331
110	132	160	200	250	335
129	160	220	280	335	450
100	147	160	185	335	450
75	100	-	-	-	-
125	150	-	-	-	-
125	150	-	-	-	-
125	150	-	-	-	-
600	600	600	600	600	600
1	0,8	0,8	0,8	0,8	0,8
6	6	6	6	6	6
RT16-2	RT16-2	RT16-3	RT16-3	RT16-4	RT16-4
315	355	450	560	750	950 (tellimisel)

NC2-225	NC2-265	NC2-330	NC2-400	NC2-630
Korpus 2	Korpus 3	Korpus 4	Korpus 5	Korpus 6
275	315	380	450	800
225	265	330	400	630
137	170	235	303	462
90	112	155	200	331
110	132	160	200	335
129	160	220	280	450
100	147	160	185	450
75	100	-	-	-
125	150	-	-	-
125	150	-	-	-
125	150	-	-	-
600	600	600	600	600
1	0,8	0,8	0,8	0,8
6	6	6	6	6
RT16-2	RT16-2	RT16-3	RT16-3	RT16-4
315	355	450	560	950 (tellimisel)

Paigaldus koos termoreleega

Kontaktorile	Paigaldatav termorelee			
	Mudel	Nimivool (A)	Soovitav kaitsmetüüp	
			aM	gG
NC6-09	 NR2-11.5	0.1~0.16	0.25	2
		0.16~0.25	0.5	2
		0.25~0.4	1	2
		0.4~0.63	1	2
		0.63~1	2	4
		1~1.6	2	4
NC6-09	 NR2-11.5	1.25~2	4	6
		1.6~2.5	4	6
		2.5~4	6	10
		4~6	8	16
		5.5~8	12	20
		7~10	12	20
NC1-09 NC1-12 NC1-18 NC1-25 NC1-32	 NR2-25	0.1~0.16	0.25	2
		0.16~0.25	0.5	2
		0.25~0.4	1	2
		0.4~0.63	1	2
		0.63~1	2	4
		1~1.6	2	4
		1.25~2	4	6
		1.6~2.5	4	6
		2.5~4	6	10
		4~6	8	16
		5.5~8	12	20
		7~10	12	20
NC1-32	 NR2-36	23~32	40	63
		28~36	40	80
NC1-40 NC1-50 NC1-65 NC1-80 NC1-95	 NR2-93	23~32	40	63
		30~40	40	100
		37~50	63	100
		48~65	63	100
		55~70	80	125
		63~80	80	125
80~93	100	160		

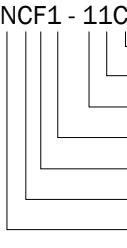
Tarvikud, NC1

Mudel	Kontaktid		Joonis
	Sulguvad kontaktid	Avanevad kontaktid	
F4-20	2	0	
F4-11	1	1	
F4-02	0	2	
F4-40	4	0	
F4-31	3	1	
F4-22	2	2	
F4-13	1	3	
F4-04	0	4	
Mudel	Aeglustuse ajavahemik	Aeglustuskontaktid	Joonis
F5-T0	0,1s~3s	avautuva + sulkeutuva	
F5-T2	0,1s~30s	avautuva + sulkeutuva	
F5-T4	10s~180s	avautuva + sulkeutuva	
F5-D0	0,1s~3s	avautuva + sulkeutuva	
F5-D2	0,1s~30s	avautuva + sulkeutuva	
F5-D4	10s~180s	avautuva + sulkeutuva	
Abilüliti F4	 <p> F4- □ □ — Avanevate kontaktide arv — Sulguvate kontaktide arv — Abilülitite komplekt </p>		
	Abilüliti F5	 <p> F5- □ □ 0: aeglustusaja vahemik 0,1...3 s 1: aeglustusaja vahemik 0,1...30 s 2: aeglustusaja vahemik 10...180 s T: tõmbeaeglustus, D: vallandumise aeglustus Aeglustusaja moodul </p>	
NCF1-11C küljele paigaldatav abilüliti		 <p> NCF1 - 11C — Küljele paigaldatav — 1 avanev kontakt — 1 sulguv kontakt — Lülitumisjärjekord — Abilülitite komplekt — Kontaktor — Ettevõtte kood </p> 	



NS2

Manuaalsed mootorikäivitid NS2

NS2-seeria manuaalseid mootorikäivateid kasutatakse kaugjuhtimisrakendustes kaitsmaks mootorit ülekoormuse, lühise ja faasi kadumise eest. Väärtused kuni 690 V, 80 A (AC3). (0,1...1,16 A - 0,16...0,25 A - 0,25...0,4 A - 0,4...0,63 A - 0,63...1 A - 1...1,6 A - 1,6...2,5 A - 2,5...4 A - 4...6,3 A - 6...10 A - 9...14 A - 13...18 A - 17...23 A - 20...25 A - 16...25 A - 25...40 A - 40...63 A - 56...80 A)

Standardid: IEC/EN 60947-5-1

Keskkonna temperatuur: -5...+40 °C

Küljele paigaldatavad abilülid:

NS2-AU20 (2NO)
NS2-AU11 (1NO & 1NC)

Ette paigaldatavad abilülid:

NS2-AE20 (2NO)
NS2-AE11 (1NO & 1NC)
NS2-UV110, NS2-UV220, NS2-UV380
NS2-SH110, NS2-SH220, NS2-SH380
NS2-FA0110 (1NC & 1NO)
NS2-FA0101 (1NC & 1NC)
NS2-FA1010 (1NO & 1NO)
NS2-FA1001 (1NO & 1NC)

Alapingelüliti:

Töövoolülilüti:

Veateatelüliti ja otsene abilüliti:

Välismõõtmed ja kinnitusmõõtmed (mm) mudelitele NS8 ja NS2

NS2 - 25

NS2 - 25X

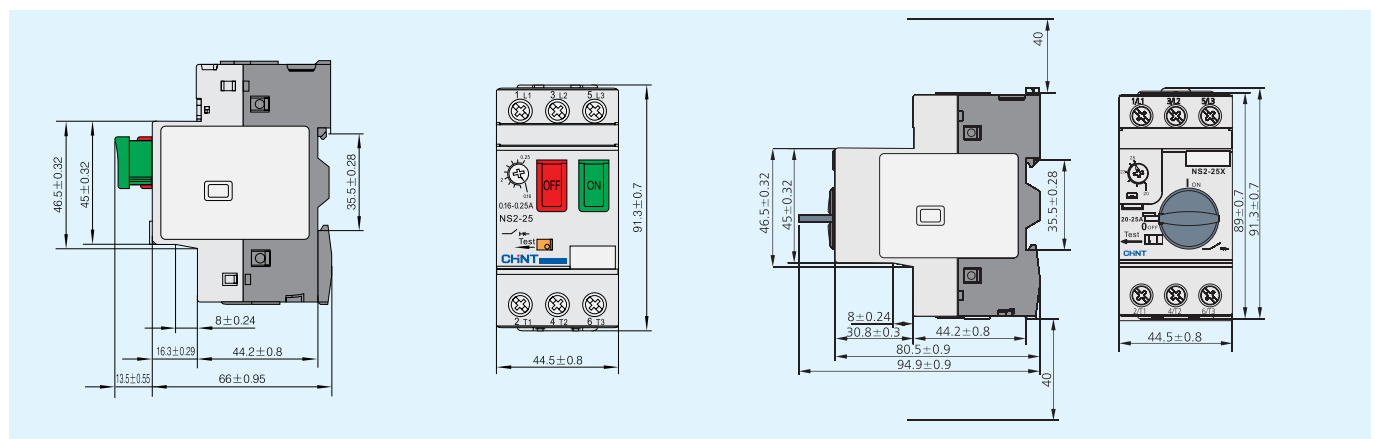
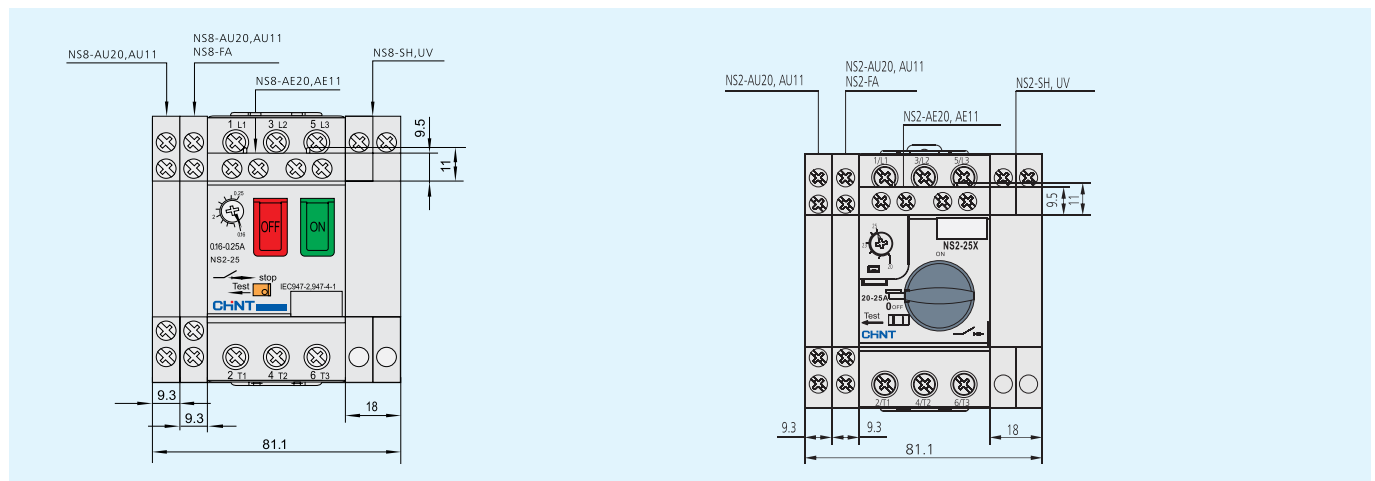

Tehnilised andmed

Mudel		NS2-25	NS2-25X			
Joonis						
Nimiisolatsioonipinge U_i (V)		690				
Nimipinge, U_e (V)		230/240, 400/415, 440, 500, 690				
Impulsspingetaluvus U_{imp} (V)		8000				
Vallandumisvoolu seadistusvahemik (A)		9~14	13~18	17~23	20~25	
Vallandusmehhanismi nimivool (A)		14	18	23	25	
Suurim nominaalne lühise lahutamise võime I_{cu} (kA)	230/240V	100	100	50	50	
	400/415V	15	15	15	15	
	440V	8	8	6	6	
	500V	6	6	4	4	
	660/690V	3	3	3	3	
Pidev nominaalne lühise lahutamise võime I_{cu} (kA)	230/240V	100	100	50	50	
	400/415V	7,5	7,5	6	6	
	440V	4	4	3	3	
	500V	4,5	4,5	3	3	
	660/690V	2,25	2,25	2,25	2,25	
Sädevahe (mm)		40	40	40	40	
3-faasilise standardmootori nimivõimsus (kW)	230/240V	3	4	5,5	5,5	
	400V	5,5	7,5	11	11	
	415V	5,5	9	11	11	
	440V	7,5	9	11	11	
	500V	7,5	9	11	15	
	660/690V	9	11	15	18,5	
Otsese magnetvallandumise vooluseadistus I_r (A)		170	223	327	327	
Kontrollkaitsme nimivool, kaitset on vaja vaid juhul kui $I_{cc} > I_{cu}$ (I_{cc} = oodata olev lühisvool)	230/240V	aM A	★	★	80	80
		gI/gG A	★	★	100	100
	400/415V	aM A	63	63	80	80
		gI/gG A	80	80	100	100
	440V	aM A	50	50	63	63
		gI/gG A	63	63	80	80
	500V	aM A	50	50	50	50
		gI/gG A	63	63	63	63
★: kaitset ei ole vaja	690V	aM A	40	40	40	40
		gI/gG A	50	50	50	50
Kaitseklass		IP2L0	IP2L0	IP2L0	IP2L0	

Tehnilised andmed

Mudel		NS2-25, NS2-25X				
Joonis						
Nimiisolatsioonipinge U_i (V)		690				
Nimipinge U_e (V)		230/240, 400/415, 440, 500, 690				
Impulsspingetaluvus U_{imp} (V)						
Vallandumisvoolu seadistusvahemik (A)		0,1~0,16	0,16~0,25	0,25~0,4	0,4~0,63	
Vallandusmehhanismi nimivool (A)		0,16	0,25	0,4	0,63	
Suurim nominaalne lühise lahutamise võime I_{cu} (kA)	230/240V	100	100	100	100	
	400/415V	100	100	100	100	
	440V	100	100	100	100	
	500V	100	100	100	100	
	660/690V	100	100	100	100	
Pidev nominaalne lühise lahutamise võime I_{cs} (kA)	230/240V	100	100	100	100	
	400/415V	100	100	100	100	
	440V	100	100	100	100	
	500V	100	100	100	100	
	660/690V	100	100	100	100	
Sädevahe (mm)		40	40	40	40	
3-faasilise standardmootori nimivõimsus (kW)	230/240V	-	-	-	-	
	400V	-	-	-	-	
	415V	-	-	-	-	
	440V	-	-	-	-	
	500V	-	-	-	t	
	660/690V	-	-	-	0,37	
Otsese magnetvallandumise vooluseadistus I_r (A)		1,5	2,4	5	8	
Kontrollkaitsme nimivool, kaitset on vaja vaid juhul kui $I_{cc} > I_{cu}$ (I_{cc} = oodata olev lühisvool)	230/240V	aM A	★	★	★	★
		gl/gG A	★	★	★	★
	400/415V	aM A	★	★	★	★
		gl/gG A	★	★	★	★
	440V	aM A	★	★	★	★
		gl/gG A	★	★	★	★
	500V	aM A	★	★	★	★
		gl/gG A	★	★	★	★
★: kaitset ei ole vaja	690V	aM A	★	★	★	★
		gl/gG A	★	★	★	★
Kaitseklass		IP2L0	IP2L0	IP2L0	IP2L0	

NS2-25, NS2-25X



690

230/240, 400/415, 440, 500, 690

8000

0,63~1	1~1,6	1,6~2,5	2,5~4	4~6,3	6~10
1	1,6	2,5	4	6,3	10
100	100	100	100	100	100
100	100	100	100	100	100
100	100	100	100	50	15
100	100	100	100	50	10
100	100	3	3	3	3
100	100	100	100	100	100
100	100	100	100	100	100
100	100	100	100	50	15
100	100	100	100	50	10
100	100	2,25	2,25	2,25	2,25
40	40	40	40	40	40
-	-	0,37	0,75	1,1	2,2
-	0,37	0,75	1,5	2,2	4
-	-	0,75	1,5	2,2	4
0,37	0,55	1,1	1,5	3	4
0,37	0,75	1,1	2,2	3,7	5,5
0,55	1,1	1,5	3	4	7,5
13	22,5	33,5	51	78	138
★	★	★	★	★	★
★	★	★	★	★	★
★	★	★	★	★	★
★	★	★	★	★	★
★	★	★	★	50	50
★	★	★	★	63	63
★	★	★	★	50	50
★	★	★	★	63	63
★	★	16	25	32	32
★	★	20	32	40	40
IP2L0	IP2L0	IP2L0	IP2L0	IP2L0	IP2L0

Kontaktorid, termoreleed ja käivitid

Kontaktorid

Kirjeldus	Tootekood	Pakend	Kirjeldus	Tootekood	Pakend
NC6-seeria kontaktorid			NR2-seeria termilised ülekoormusreleed		
NC6-0910 (0910) 3-pooluseline mähis 230 VAC 1NO	NC60910230V50HZ	1	NC6-seeria		
NC6-0901 (0901) 3-pooluseline mähis 230 VAC 1NC	NC60901230V50HZ	1	NR2-115 0.1-0.16A	NR2115ZA	1
NC6-0910 (0910) 3-pooluseline mähis 24 VAC 1NO	NC6091024V50HZ	1	NR2-115 0.16-0.25A	NR2115ZB	1
NC6-0901 (0901) 3-pooluseline mähis 24 VAC 1NO	NC6090124V50HZ	1	NR2-115 0.25-0.4A	NR2115ZC	1
NC6-0904 (0908) 4-pooluseline mähis 230 VAC	NC60908230V50HZ	1	NR2-115 0.4-0.63A	NR2115ZD	1
			NR2-115 0.63-1A	NR2115ZE	1
			NR2-115 1-1.6A	NR2115ZF	1
			NR2-115 1.25-2A	NR2115ZG	1
			NR2-115 1.6-2.5A	NR2115ZH	1
			NR2-115 2.5-4A	NR2115ZI	1
			NR2-115 4-6A	NR2115ZJ	1
			NR2-115 5.5-8A	NR2115ZK	1
			NR2-115 7-10A	NR2115ZL	1
			NR2-115 9-13A	NR2115ZM	1
NC1-seeria kontaktorid			NC1-seeria		
3P NC1-0901(0910) 4 kW mähis 230VAC 1NO	NC1093P10	1	NR2-25G 0.1-0.16A	NR225A	1
3P NC1-1201(1210) 5,5 kW mähis 230VAC 1NO	NC1123P10	1	NR2-25G 0.16-0.25A	NR225B	1
3P NC1-1201(1201) 5,5 kW mähis 230VAC 1NC	NC1123P01	1	NR2-25G 0.25-0.4A	NR225C	1
3P NC1-1801(1810) 7,5 kW mähis 230VAC 1NO	NC1183P10	1	NR2-25G 0.4-0.63A	NR225D	1
3P NC1-2501(2510) 11 kW mähis 230VAC 1NO	NC1253P10	1	NR2-25G 0.63-1A	NR225E	1
3P NC1-3201(3210) 15 kW mähis 230VAC 1NO	NC1323P10	1	NR2-25G 1-1.6A	NR225F	1
3P NC1-4011 18,5 kW mähis 230VAC 1NO	NC1403P11	1	NR2-25G 1.25-2A	NR225G	1
3P NC1-5011 22 kW mähis 230VAC 1NO	NC1503P11	1	NR2-25G 1.6-2.5A	NR225H	1
3P NC1-6511 30 kW mähis 230VAC 1NO	NC1653P11	1	NR2-25G 2.5-4A	NR225I	1
3P NC1-8011 37 kW mähis 230VAC 1NO	NC1803P11	1	NR2-25G 4-6A	NR225J	1
3P NC1-9511 45 kW mähis 230VAC 1NO	NC1953P11	1	NR2-25G 5.5-8A	NR225K	1
			NR2-25G 7-10A	NR225L	1
			NR2-25G 9-13A	NR225M	1
			NR2-25G 12-18A	NR225N	1
			NR2-25G 17-25A	NR225O	1
			NR2-36G 23-32A	NR236P	1
			NR2-36G 28-36A	NR236Q	1
			NR2-93G 23-32A	NR293A	1
			NR2-93G 30-40A	NR293S	1
			NR2-93G 37-50A	NR293T	1
			NR2-93G 48-65A	NR293U	1
			NR2-93G 55-70A	NR293V	1
			NR2-93G 63-80A	NR293X	1
			NR2-93G 80-93A	NR293Y	1
			NR2-200G 80-125A	NR2200A	1
			NR2-200G 100-160A	NR2200B	1
			NR2-200G 125-200A	NR2200C	1
			NS2-seeria manuaalsed mootorikäivitid		
			NS2-25 0.1-0.16A	NS225A	1
			NS2-25 0.16-0.25A	NS225B	1
			NS2-25 0.25-0.4A	NS225C	1
			NS2-25 0.4-0.63A	NS225D	1
			NS2-25 0.63-1A	NS225E	1
			NS2-25 1-1.6A	NS225F	1
			NS2-25 1.6-2.5A	NS225G	1
			NS2-25 2.5-4A	NS225H	1
			NS2-25 4-6.3A	NS225I	1
			NS2-25 6-10A	NS225J	1
			NS2-25 9-14A	NS225K	1
			NS2-25 13-18A	NS225L	1
			NS2-25 17-23A	NS225M	1
			NS2-25 20-25A	NS225N	1
			NS2-80B 25-40A	NS280B40A	1
			NS2-80B 40-63A	NS280B63A	1
			NS2-80B 56-80A	NS280B80A	1
			NS2 Tarvikud		
			NS2-MC nupukarp		
			Töövoolulüliti NS2-SH220		
			Töövoolulüliti NS2-SH380		
			Veateatelüliti/Abilüliti NS2-FA1001		
			NS2-AU11		
			Alapingelüliti NS2-UV220		
			Alapingelüliti NS2-UV380		
NC2-seeria kontaktorid					
3P NC2-115 mähis 230VAC	NC21153P	1			
3P NC2-150 mähis 230VAC	NC21503P	1			
3P NC2-185 mähis 230VAC	NC21853P	1			
3P NC2-225 mähis 230VAC	NC22253P	1			
3P NC2-265 mähis 230VAC	NC22653P	1			
3P NC2-330 mähis 230VAC	NC23303P	1			
3P NC2-400 mähis 230VAC	NC24003P	1			
3P NC2-500 mähis 230VAC	NC25003P	1			
3P NC2-630 mähis 230VAC	NC26303P	1			
4P NC2-150 mähis 230VAC	NC21504P	1			
4P NC2-630 mähis 230VAC	NC26304P	1			
NCH8-seeria modulikontaktorid					
NCH8-20/2P 20A mähis 230VAC 2NO	NCH82020230V	1			
NCH8-25/4P 25A mähis 230VAC 4NO	NCH82540230V	1			
NCH8-40/4P 40A mähis 230VAC 4NO	NCH84040230V	1			
NCH8-63/4P 63A mähis 230VAC 4NO	NCH86340230V	1			
Abilülidid					
F5		1			
F4-20 abiväelane kontakt 2NO	F420	10			
F4-11 1NO 1NC	F411	10			
F4-02 2NC	F402	10			
F4-40 4NO	F440	10			
F4-11 4NC	F411	10			
NCF11C 1NO 1NC paigaldusküljele	NCF11C	10			
NC1 tarvikud					
AC-pool mudelile NC1					
CJX2(NC1)-09/12/18/25/32 ristlukustusseade	CJX2NC10932	1			
CJX2(NC1)-40/65 ristlukustusseade	CJX2NC14065	1			
CJX2(NC1)-80/95 ristlukustusseade	CJX2NC18095	1			



NP8

Juhtnupud NP8

NP8-seeria juhtnuppe ja lüliteid kasutatakse vooluahelate kaugjuhtimiseks ja kontrollimiseks. Nimi-väärtused kuni 230 V AC, 3 A (AC-15) või 125 V DC, 0,55 A (DC-13).

Standardid: IEC/EN 60947-5-1

Kaitseklass: IP54

Paigaldusava suurus: 22mm

Keskkonna temperatuur: -5 °C ... +40 °C

Kontaktid: 2 kontakti (max)

Osutamine: saadaval on nii valgustusega kui ka valgustamata mudelid

Lüliti: saadaval lähtestuvad ja lukustuvad mudelid

Esirõnga materjal: plast

Tööelemendid: sile nupp, seennupp, valikunupp, topelnupp, märgulamp

Nuppude värvitoonid: punane, must, roheline, sinine, kollane



ND16

Märgulambid ND16, multiLED

ND16-seeria märgulampe kasutatakse kaugvaatluseks.

Nimiväärtused kuni 400 V (AC/DC).

Standardid: IEC/EN 60947-5-1

Kaitseklass: IP65

Paigaldusava suurus: 22mm

Elektriline kasutusiga: 30×10³ tundi

Keskkonna temperatuur: -5 °C ... +40 °C

Klaasi värvitoonid: punane, must, roheline, sinine, kollane

NP8

Kirjeldus

NP8-BN valgustuseta nupp**

NP8-xxBN BLACK

NP8-xxBN GREEN

NP8-xxBN RED

NP8-xxBN YELLOW

NP8-xxBN BLUE

NP8-xxBN WHITE

NP8-BND Valgustusega nupp**

NP8-xxBND GREEN

NP8-xxBND RED

NP8-xxBND YELLOW

NP8-xxBND BLUE

NP8-xxBND WHITE

NP8-ZS Seennupp Ø 60mm**

NP8-xxZS/24 RED

NP8-X** Valikunupp, 2 asendit**

NP8-xxX/21 BLACK

NP8-xxX/21 GREEN

NP8-xxX/21 RED

NP2-XD** Valgustusega valikunupp, 2 asendit**

NP8-xxXD/21 GREEN

NP8-xxXD/21 RED

NP8-X** Valikunupp, 3 asendit**

NP8-xxX/31 BLACK

NP8-xxX/31 GREEN

NP8-xxX/31 RED

NP8-XD** Valgustusega valikunupp, 3 asendit**

NP8-xxXD/31 GREEN

NP8-xxXD/31 RED

NP8-X** Valikunupp, 2 asendit, vedruga lähtestus**

NP8-xxX/22 BLACK

NP8-XD** Valgustusega valikunupp, 2 asendit, vedruga lähtestus**

NP8-xxXD/22 GREEN

NP8-X** Valikunupp, 3 asendit, vedruga lähtestus**

NP8-xxX/33 BLACK

NP8-X** Valikulüliti, 3 asendit, 1 asend vedruga lähtestus**

NP8-xxX/37 BLACK

NP8-XD** Valgustusega valikulüliti, 3 asendit, 1 asend vedruga lähtestus**

NP8-xxXD/37 GREEN

NP8-Y** Võtmega lüliti**

NP8-xxY/21

ND16

Kirjeldus

Tootekood

Pakend

24VAC/DC sinine

ND1622DS224VB

10

24VAC/DC roheline

ND1622DS224VG

10

24VAC/DC punane

ND1622DS224VR

10

24VAC/DC valge

ND1622DS224VW

10

24VAC/DC kollane

ND1622DS224VY

10

230VAC/DC sinine

ND1622DS4230VB

10

230VAC/DC roheline

ND1622DS4230VG

10

230VAC/DC punane

ND1622DS4230VR

10

230VAC/DC valge

ND1622DS4230VW

10

230VAC/DC kollane

ND1622DS4230VY

10

G = roheline, R = punane, Y = kollane, W = valge, B = sinine

Juhtnupud ja märgulambid



Nupud NP8

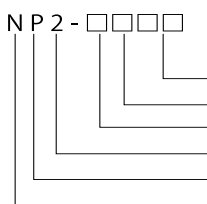

Süvisnupp
NP8-□□BN/□

P03



Eenduv nupp
NP8-□□GN/□

P04



Seennupp,
iselähtestuv
NP8-□□M/□

P05



Seennupp, iselukustuv,
lähtestamiseks keerake
NP8-□□ZS/□□

P07



Valgustusega seennupp,
iselähtestuv
NP8-□□MD/□□

P06



Valgustusega kahepoolne
nupp
NP8-□□SD

P08



Valikulüliti
NP8-□□×/□□

P09



Valgustusega
valikulüliti
NP8-□□×D/□

P11



Võtmega lüliti
NP8-□ Y/□□

P11



Kahepoolne nupp
NP8-□□S

P08



Valgustusega süvisnupp
NP8-□□BND/□

P03



Valgustusega eenduv nupp
button
NP8-□□GND/□

P04



Märgulamp
NP8-D/□

P09

Märgulambid ND16

ND 16-22 DS/4	Lamp -Pinge	Mudel	Värv
	LED: AC 110V, 230V, 400V	ND16-22DS/4 (W)	○
		ND16-22DS/4 (G)	●
		ND16-22DS/4 (R)	●
		ND16-22DS/4 (Y)	●
		ND16-22DS/4 (B)	●

Moodularvestusega märgulambid, juhtlülitid, koormuslülitid ja ajareleed



NZK

Vahetuslüüti NZK2-32

1. Üldist

1.1 Sertifikaadid: KEMA

1.2 Elektrilised väärtused: 32 A, 250 V AC, 50/60 Hz

1.3 Standardid: IEC 60669-1

2. Tavapärased paigaldus- ja kasutustingimused

2.1 Keskkonna temperatuur: -5...+40 °C, keskmine väärtus 24 tunni jooksul ei või ületada +35 °C

2.2 Kõrgus: 2000 m

2.3 Ilmastikutingimused: paigalduskoha õhu suhteline niiskus ei või ületada väärtust 50% kõrgeimal töötemperatuuril +40 °C, madalamatel temperatuuridel võib suhteline õhuniiskus olla ka suurem. Näiteks temperatuuril +20 °C võib suhteline õhuniiskus olla 90%. Niiskuse kondenseerumine vältida sobivate vahendite abil

2.4 Kinnitusviis: standardsiinile TH35-7.5, kinnitusalusel kõrvalekalle vertikaalset max 5°



NH9

Lüüti

1. Üldist

1.1 Elektrilised väärtused: 32 A, 240 V AC, 50/60 Hz

1.2 Kaitseklass IP20

1.3 Kasutuskategooria AC-22A

1.4 Standardid: IEC/EN 60947-3

2. Tavapärased paigaldus- ja kasutustingimused

2.1 Keskkonna temperatuur: -5...+40 °C, keskmine väärtus 24 tunni jooksul ei või ületada +35 °C

2.2 Määrumisaste: II

Märgulambid siinile ND9

1. Üldist

1.1 Elektrilised väärtused: 230 V AC, 50/60 Hz

1.2 Nimiisolatsioonipinge U_i : 500 V

1.3 Kaitseklass: IP20

1.4 Nimivool: 20 mA

1.5 Kasutusaeg: LED 30 000 h

1.6 Standardid: IEC/EN 60947-5-1

2. Tavapärased paigaldus- ja kasutustingimused

2.1 Keskkonna temperatuur: -5...+40 °C, keskmine väärtus 24 tunni jooksul ei või ületada +35 °C

2.2 Kõrgus: 2000m

2.3 Ilmastikutingimused:

Paigalduskoha õhu suhteline niiskus ei või ületada väärtust 50% kõrgeimal töötemperatuuril +40 °C, madalamatel temperatuuridel võib suhteline õhuniiskus olla ka suurem. Näiteks temperatuuril +20 °C võib suhteline õhuniiskus olla 90%. Niiskuse kondenseerumine vältida sobivate vahendite abil.

2.4 Kasutuskategooria: II, III

2.5 Määrumisaste: II

2.6 Kinnitusviis: standardsiinile TH35-7.5, kinnitusalusel kõrvalekalle vertikaalset max 5°



ND9

NH9

Kirjeldus	Tootekood	Pakend
NH9-32 1P 32A	NH91P32A	1
NH9-32 2P 32A	NH92P32A	1
NH9-32 3P 32A	NH93P32A	1
NH9-32 4P 32A	NH94P32A	1

NZK

Kirjeldus	Tootekood	Pakend
NZK1-32/1(1P)	NZK1321P	1
NZK2-32/1(1P)		1
NZK1-32/2(2P)	NZK1322P	1
NZK2-32/2(2P)		1

ND9

Kirjeldus	Pakend
ND91G230V	1
ND91R230V	1
ND91W230V	1
ND91Y230V	1
ND923031	1
ND923032	1
ND923033	1
ND92GR230V	1
ND92WW230V	1
ND9PR	1

Ajareeled NTE8:

Ajarelee



Ajareeled NTE8

1. Üldist

- 1.1 Elektrilised väärtused: 5 A / 1 A, AC 230 V / DC 30 V, AC 50/60 Hz
- 1.2 Nimiisolatsioonipinge U_i : 250 V
- 1.3 Määrumisaste: II
- 1.4 Kaitseklass: IP20
- 1.5 Kasutusiga: 100 X 103
- 1.6 Standardid: IEC/EN 60947-5-1

Mudel	Lepingu number	Toite nimipinge (V)	Nimitalitluspinge (V)	Nimitalitlusvool (A)	Viivituse vahemik (S)	Viitaja tüüp
NTE8-10A	1 NO	AC230	AC230	5	0,1~10	Väljalülituse viitaeg
NTE8-120A	1 NO	AC230	AC230	5	10~120	Väljalülituse viitaeg
NTE8-480A	1 NO	AC 230	AC230	5	30~480	Väljalülituse viitaeg
NTE8-10B	1 NO	AC230, DC24, AC24	AC230	5	0,1~10	Sisselülituse viitaeg
			DC30	1		
NTE8-120B	1 NO	AC230, DC24, AC24	AC230	5	10~120	Sisselülituse viitaeg
			DC30	1		
NTE8-480B	1 NO	AC230, DC24, AC24	AC230	5	30~480	Sisselülituse viitaeg
			DC30	1		

NTE8:

Kirjeldus	Tootekood	Pakend
Ajarelee 1NO 230VAC 0,1-1s	NTE810B	1
Ajarelee 1NO 230VAC 10-120s	NTE8120B	1
Ajarelee 1NO 230VAC 30-48s	NTE8480B	1
Ajarelee 1NO 230VAC 5A 0,1-10s	NTE810A	1
Ajarelee 1NO 230VAC 5A 10-120s	NTE8120A	1
Ajarelee 1NO 230VAC 5A 30-480s	NTE8480A	1

Pealüliti NH4



1. Üldist

- 1.1 Avatud asendis vastavad kontaktid isoleerivuse nõuetele.
- 1.2 Loodud ühilduvaks NB-seeria kaitselülite/rikkevoolulülitega.

2. Tehnilised andmed

	Standard		IEC/EN 60947-3
Elektrilised omadused	Nimipinge Ue	B	230/400
	Nimivool Ie	A	32, 63, 100, 125
	Nimisagedus	Hz	50/60
	Impulsspinge taluvus, nimiväärtus (1,2/50) Uimp		4,000
	Hetkeline tippvool Icw		12Ie, 1s
	Nimilahutusvõime		3Ie, 1.05Ue, cosφ=0.65
	Nominaalne lühise lahutamise võime		20Ie, t=0.1s
	Isolatsioonikindlus, 1 min jooksul nimisagedusel	kV	2.5
	Isolatsioonipinge Ui	V	500
	Määrumisaste		2
	Kasutuskategooria		AC-22A
Mehaanilised omadused	Elektriline kasutusiga		1,500
	Mehaaniline kasutusiga		8,500
	Kaitseklass		IP20
	Kasutustemperatuur (keskmine väärtus < 35 °C)	°C	-5...+40
	Hoiukoha temperatuur	°C	-25...+70
Paigaldamine	Ühendusviis		juhe / hark-voolusiin / kammsiin
	Ühendused kaablitele ülevalt/alt	mm ²	50
		AWG	18-1/0
	Ühendused voolusiinidele ülevalt/alt	mm ²	50
		AWG	18-1/0
	Pingutusmoment	N*m	2.5
		ln-lbs.	22
Ühendused		ülevalt ja alt	

Tellimisandmed

★ NH4, 1P



Ie (A)	Ue (V~)	kast	Tellimiskood	
			Standardmudel	RoHS
32	230	180	153213	971014
63	230	180	153214	971015
100	230	180	153215	971016
125	230	180	-	983281

★ NH4, 2P



Ie (A)	Ue (V~)	kast	Tellimiskood	
			Standardmudel	RoHS
32	400	90	153216	971017
63	400	90	153217	971018
100	400	90	153218	971019
125	400	90	-	983282

★ NH4, 3P



Ie (A)	Ue (V~)	kast	Tellimiskood	
			Standardmudel	RoHS
32	400	60	153219	971020
63	400	60	153220	971021
100	400	60	153221	971022
125	400	60	-	983283

★ NH4, 4P



Ie (A)	Ue (V~)	kast	Tellimiskood	
			Standardmudel	RoHS
32	400	45	153222	971023
63	400	45	153223	971024
100	400	45	153224	971025
125	400	45	-	983284

Välismõõtmed ja kinnitusmõõtmed (mm)

Välismõõtmed ja kinnitusmõõtmed

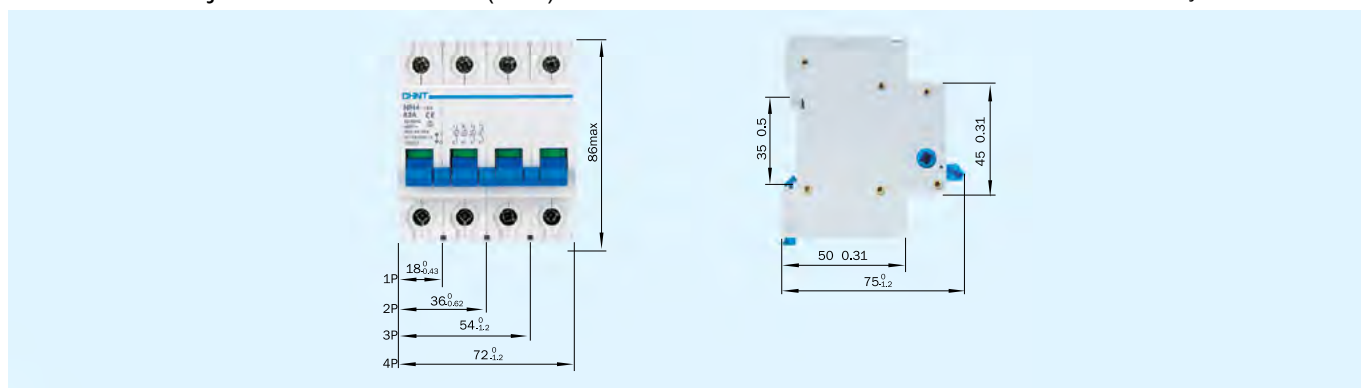

Kirjeldus	Tootekood	Pakend
Isolatsioonilüüti 1-P N32A	NH41001N32A	1
Isolatsioonilüüti 1-P N40A	NH41001N40A	1
Isolatsioonilüüti 1-P N63A	NH41001N63A	1
Isolatsioonilüüti 1-P 100A	NH41001N100A	1
Isolatsioonilüüti 2-P N32A	NH41002N32A	1
Isolatsioonilüüti 2-P N63A	NH41002N63A	1
Isolatsioonilüüti 2-P 100A	NH41002N100A	1

Kirjeldus	Tootekood	Pakend
Isolatsioonilüüti 2-P 125A	NH41002N125A	1
Isolatsioonilüüti 3-P N32A	NH41003N32A	1
Isolatsioonilüüti 3-P N63A	NH41003N63A	1
Isolatsioonilüüti 3-P 100A	NH41003N100A	1
Isolatsioonilüüti 4-P N32A	NH41004N32A	1
Isolatsioonilüüti 4-P N63A	NH41004N63A	1
Isolatsioonilüüti 4-P 100A	NH41004N100A	1



Tehnilised andmed

- 2.1 Sekundaarahela vool Isn: 5 A
- 2.2 Nimipinge Ue: 720 V
- 2.3 Sagedus: 50/60 Hz
- 2.4 Mõõteseadme koefitsient (FS): 10
- 2.5 Kasutustemperatuur: -25...+40 °C, õhuniiskus < 80%
- 2.6 Standardid: IEC 60044-1
- 2.7 Paigaldus: DIN-siinile või voolusiinile



Tehnilised andmed

- 2.1 Sekundaarahela vool Isn: 5 A
- 2.2 Nimipinge Ue: 720 V
- 2.3 Sagedus: 50/60 Hz
- 2.4 Mõõteseadme koefitsient (FS): 10
- 2.5 Kasutustemperatuur: -25...+40 °C, õhuniiskus < 80%
- 2.6 Standardid: IEC 60044-1
- 2.7 Paigaldus: voolusiinile

Voolutrafod

Voolutrafo 0,2S täpsus	Tootekood	Pakend
100A/5A, Ø30, täpsus 0.2S, 1 turn	BH066IB10053002S	1
125A/5A, Ø30, täpsus 0.2S, 1 turn	BH066IB12553002S	1
1500A/5A, Ø100, täpsus 0.2S, 1 turn	BH066II1500510002S	1
1500A/5A, Ø80, täpsus 0.2S, 1 turn	BH066II150058002S	1
1600A/5A, Ø100, täpsus 0.2S, 1 turn	BH066II1600510002S	1
1600A/5A, Ø80, täpsus 0.2S, 1 turn	BH066II160058002S	1
2000A/5A, Ø100, täpsus 0.2S, 1 turn	BH066II2000510002S	1
2500A/5A, Ø120, täpsus 0.2S, 1 turn	BH066II2500512002S	1
600A/5A, Ø60, täpsus 0.2S, 1 turn	BH066I60056002S	1
800A/5A, Ø60, täpsus 0.2S, 1 turn	BH066I80056002S	1

Voolutrafo 0,5S täpsus	Tootekood	Pakend
1500A/5A, Ø100, täpsus 0.5, 1 turn	BH066II1500510005	1
1500A/5A, Ø80, täpsus 0.5, 1 turn	BH066II150058005	1
1600A/5A, Ø100, täpsus 0.5, 1 turn	BH066II1600510005	1
1600A/5A, Ø80, täpsus 0.5, 1 turn	BH066II160058005	1
2000A/5A, Ø100, täpsus 0.5, 1 turn	BH066II2000510005	1
2500A/5A, Ø100, täpsus 0.5, 1 turn	BH066II2500510005	1
2500A/5A, Ø120, täpsus 0.5, 1 turn	BH066II2500512005	1
3000A/5A, Ø120, täpsus 0.5, 1 turn	BH066II3000512005	1
4000A/5A, Ø120, täpsus 0.5, 1 turn	BH066II4000512005	1
600A/5A, Ø60, täpsus 0.5, 1 turn	BH066I60056005	1
800A/5A, Ø60, täpsus 0.5, 1 turn	BH066I80056005	1



Paigaldussiin, tsingitud ja passiveeritud

Standardid
EN 60715

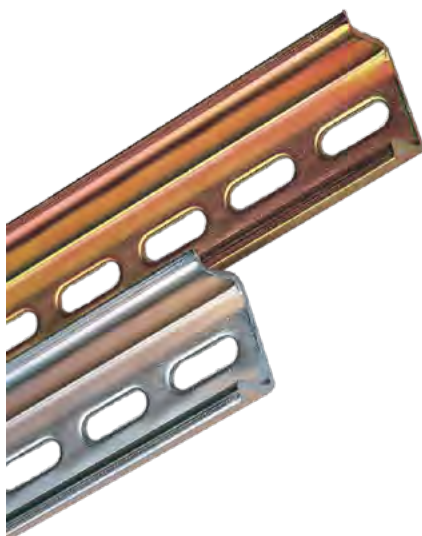

Osa nr.				
Pikkus	Kollane	Valge	Pakendi	kaal, kg
1 M	011011 002 04000	012011 002 04000	20 M	0,300 / M
2 M	011021 002 04000	012021 002 04000	40 M	0,300 / M

TS 35/F6

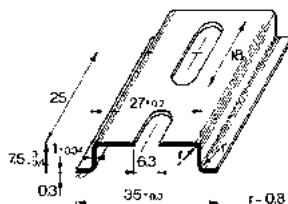

Osa nr.				
Pikkus	Kollane	Valge	Pakendi	kaal, kg
1 M	011011 004 04000	012011 004 04000	10 M	0,615 / M
2 M	011021 004 04000	012021 004 04000	20 M	0,615 / M
3 M	011031 004 04000	012031 004 04000	30 M	0,615 / M

TS 35/CF6

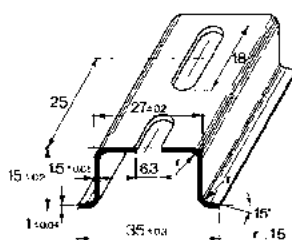



- GF-A6/4 hall, küljelamellidega, auguread põhjal
- GF-DIN-SH helehall, halogeenivaba materjal

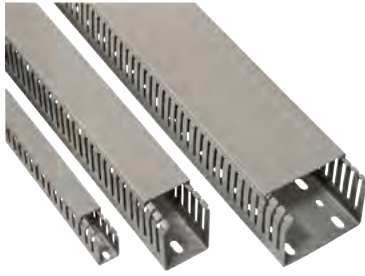

GF-A6/4
Värv: hall
GF-DIN-SH
Standard DIN 43659

GF-A6/4 kaablirennid

Küljeavad ja lamellid: avad 4 mm - lamellid 6 mm
Standardpikkus: 2 meetrit (muud pikkused tellimisel)
Minimaalne partii: 1 pakend (põhjad ja katted on samas pakendis)
Värv: hall (GY 013) (RAL 7030)
Materjal: PVC (kvaliteet 9051)
Muud tehnilised omadused: nõudmisel

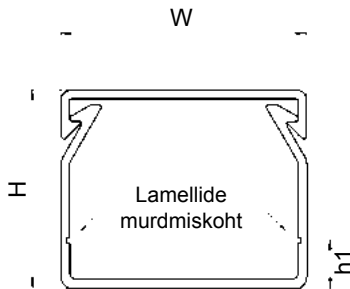

Kirjeldus	Tootekood	S-number	pakend	Mõõtmed		
				H	W	h1
Kõrgus 35 mm						
GF-A6/4 35x20	08450045013	1419200	48 m	35	20	8
GF-A6/4 35x43	08450065013	1419201	24 m	35	43	8
Kõrgus 42 mm						
GF-A6/4 42x30	08450085013	1419202	48 m	42	30	7
GF-A6/4 42x43	08450095013	1419203	24 m	42	43	7
GF-A6/4 42x60	08450105013	1419204	24 m	42	60	7
GF-A6/4 42x80	08450115013	1419205	24 m	42	80	7
Kõrgus 60 mm						
GF-A6/4 60x30	08450175013	1419206	48 m	60	30	9
GF-A6/4 60x43	08450185013	1419207	24 m	60	43	9
GF-A6/4 60x60	08450195013	1419208	24 m	60	60	9
GF-A6/4 60x80	08450205013	1419210	24 m	60	80	15
GF-A6/4 60x100	08450204013	1419209	24 m	60	100	15
GF-A6/4 60x120	08450215013	1419211	12 m	60	120	15
Kõrgus 80 mm						
GF-A6/4 80x30	08450225013	1419212	24 m	80	30	15
GF-A6/4 80x43	08450235013	1419213	24 m	80	43	15
GF-A6/4 80x60	08450245013	1419214	24 m	80	60	15
GF-A6/4 80x80	08450255013	1419216	24 m	80	80	15
GF-A6/4 80x100	08450254013	1419215	12 m	80	98	15
GF-A6/4 80x120	08450265013	1419217	12 m	80	120	15
Kõrgus 100 mm						
GF-A6/4 100x30	08450285013	1419218	24 m	100	30	20

Kaablirenn GF-DIN-SH-A7/5 (halogeenivaba) küljelamellide ja auguridatega põhjal

Küljeavad ja lamellid: avad 5 mm, lamellid 7,5 mm (jaotusmõõt 12,5 mm)
Standardpikkus: 2 m (muud pikkused tellimisel)
Minimaalne partii: 1 pakend (põhjad ja katted on samas pakendis)
Värv: helehall (GY 013) RAL 7035

mud	tootenumber	S-number	pakend	välismõõtmed		
				H	W	h1
Kõrgus 50 mm						
GF-DIN-SH-A7/5 50x50	0848 0151 013	1419219	24 m	48	48	8

GF-A6/4 kaablirennid tarnitakse standardmõõdmetes, kahepoolse eelkinnitusteibiga varustatult.



CHINT on Aasia suurim ja üks maailma kolmest suuremast kesk- ja juhtimiskomponentide valmistajaid. CHINT on turul laialdaselt tuntud kaubamärk ja CHINTi komponentidel on mitmekülgsed rahvusvahelised sertifikaadid.

Chinti tootevalikusse kuuluvad muuhulgas kaitselülitid, rikkevoolukaitsmed, kontaktorid ja muud juhtseadmed. Chint pakub kulutõhusaid komponentide variante, mis on laialdaselt tunnustatud ka rahvusvahelistel turgudel.

Elektrilevi heakskiit toodetel 1- 125 A.
Küsi CHINTi tootenäidiseid ja pakkumist.