



PRODUCT DATASHEET

PANEL VAL 600 UGR < 19 36 W 4000 K WT

PANEL VALUE 600 UGR < 19 | Square recessed panel luminaires with low glare, 600x600 mm



Areas of application

- Direct replacement for luminaires with fluorescent lamps
- Offices, conference rooms
- Reception areas, foyers, corridors, elevators
- Suitable for recessed ceiling systems with grid size of 600 x 600 mm

Product benefits

- Value for money luminaire
- Good glare reduction (UGR < 19)
- Low flicker light thanks to special electronic control gear
- Energy savings thanks to system efficacy of up to 100 lm/W
- External driver for extended flexibility and easy installation
- Versions with DALI ECG available

Product features

- Lifetime (L70/B50): up to 50,000 h (at 25 °C)
- Extruded aluminum frame
- Polystyrene diffuser



TECHNICAL DATA

Electrical data

Nominal wattage	36.00 W
Nominal voltage	220...240 V
Mains frequency	50...60 Hz
Nominal current	170 mA
Inrush current	10.4 A
Inrush current time T_{h50}	200 μ s
Max. number of luminaires per miniature circuit breaker B16	19
Max. number of luminaires per miniature circuit breaker C10	19
Max. number of luminaires per miniature circuit breaker C16	30
Power factor λ	> 0.90
Total harmonic distortion	< 15 %
Protection class	II
Operating mode	External LED driver

Photometrical data

Luminous flux	3600 lm
Luminous efficacy	100 lm/W
Color temperature	4000 K
Light color (designation)	Cool White
Color rendering index Ra	> 80
Standard deviation of color matching	5 sdc _m
Luminous intensity	-
Low flicker	Yes
Flickering metric (Pst LM)	-
Stroboscope effect metric (SVM)	-
Photobiological safety group acc. to EN62778	RG0
Beam angle	90 °
UGR	< 19

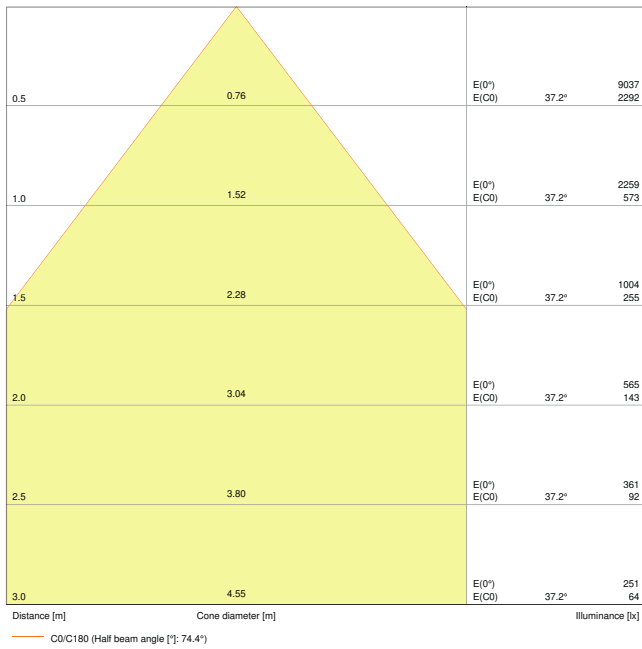

PL VAL 600 36W 4000K UGR19

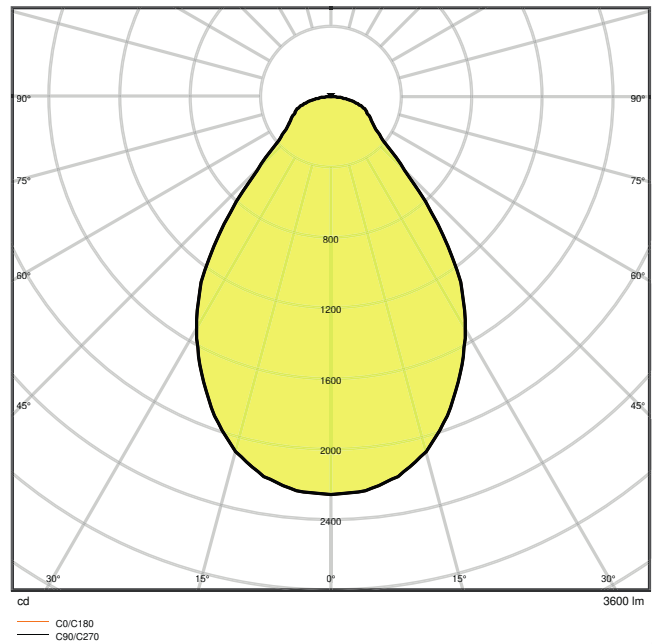

PL VAL 600 36W 4000K UGR19

Dimensions & Weight

Length	595.00 mm
Width	595.00 mm
Height	35.00 mm
Product weight	1800.00 g

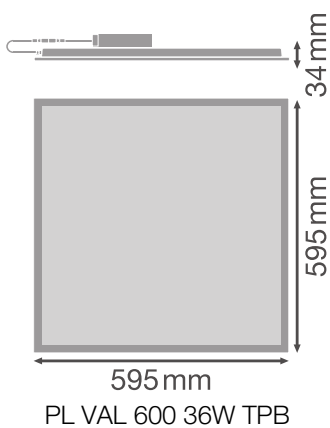

Materials & Colors

Product color	White
Housing color	White
Body material	Steel
Cover material	Polystyrene (PS)
Light emitting surface material	Polystyrene
Glow Wire Test according to IEC 60695-2-12	650 °C
Mercury content	0.0 mg

Application & Mounting

Ambient temperature range	-10...+45 °C
Type of connection	Screwless terminal
Type of protection	IP40
Protection class IK (shock resistance)	IK02
Dimmable	No
Mounting type	Recessed/Suspended/Surface
Mounting location	Ceiling / Wall
Application environment	Indoor
Mounting length	580 mm
Mounting width	580 mm
Mounting depth	50,0 mm
LED module replaceable	Not replaceable

Lifespan

Lifespan L70/B50 at 25 °C	50000 h ¹⁾
Lifespan L80/B10 at 25 °C	50000 h ¹⁾
Lifespan L90/B10 at 25 °C	30000 h
Number of switching cycles	25000

¹⁾ t[h]: L70 / B50 @ 25 °C (Ta), t[h]: L80 / B10 @ 25 °C (Ta), t[h]: L90 / B10 @ 25 °C (Ta)









Control gear

ECG - Output ripple current	≤ 5 %
-----------------------------	-------

Certificates & Standards

Standards	CE / CB / EAC
Luminaire with limited surface temperature, "D sign"	No
Ball shot safe	No





Accessories Optional







Product image	Product name	EAN
	PANEL Suspension Kit	4058075402928
	CONNECTOR BOX 5POLE L/N 4x	4058075473010
	PANEL 600 SURFACE MOUNT KIT H70 VAL	4058075402843
	PANEL 600 SURFACE MOUNT KIT H75	4058075472914
	PANEL RECESSED MOUNT CLIPS VAL 4x	4058075409859
	PANEL 600 RECESSED MOUNT FRAME	4058075402881
	PANEL SECURITY KIT 4x	4058075472990
	EM CONVERSION BOX	4058075237025

EQUIPMENT / ACCESSORIES

- Accessories for several mounting options available
- External control gear included
- Security brackets included

DOWNLOAD DATA

Documents and certificates		Document name
	User Instruction	PL VAL UI
	User Instruction	PL VAL 600 625
	Addon Technical Information	LSI PL VAL AND PL VAL DALI
	Addon Technical Information	LSI PL VAL AND PL VAL DALI
	Declarations of conformity	PL VAL

Photometric and lighting design files		Document name
	IES file (IES)	PL VAL 600 36W 4000K UGR19
	LDT file (Eulumdat)	PL VAL 600 36W4000K UGR19
	ROLF file (RELUX)	PL VAL 600 36W
	UGR file (UGR table)	PL VAL 600 36W 4000K UGR19
	LDC typ cone	PL VAL 600 36W 4000K UGR19
	LDC typ polar	PL VAL 600 36W 4000K UGR19

Tender texts	Document name
 Tender documents	PANEL VALUE 600 UGR 19 36 W 4000 K WT-EN

LOGISTICAL DATA

Product code	Packaging unit (Pieces/Unit)	Dimensions (length x width x height)	Gross weight	Volume
4058118142200	Folding box 1	602 mm x 40 mm x 648 mm	2192.00 g	15.60 dm ³
4058118142217	Shipping box 4	667 mm x 182 mm x 634 mm	10015.00 g	76.96 dm ³

The mentioned product code describes the smallest quantity unit which can be ordered. One shipping unit can contain one or more single products. When placing an order, for the quantity please enter single or multiples of a shipping unit.

ADDITIONAL CATALOG INFORMATION

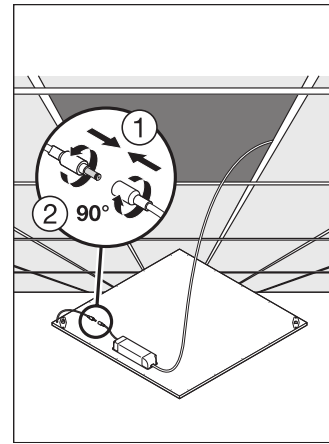
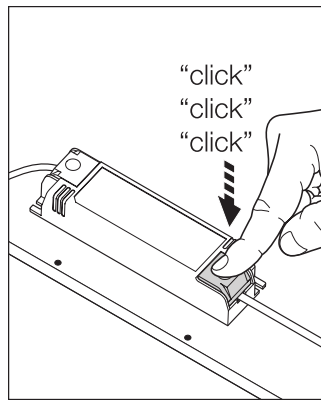
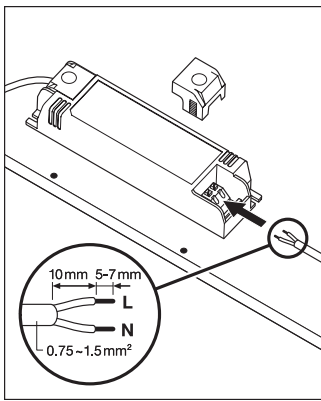

References / Links

– For Guarantee see www.ledvance.com/guarantee

DISCLAIMER

Subject to change without notice. Errors and omission excepted. Always make sure to use the most recent release.